



## EROSION CONTROL LEGEND

DESCRIPTION	PLAN SYMBOL
SILT FENCE	
CLEARING LIMITS	
LIMITS OF DISTURBANCE	
SUBSURFACE DRAIN	
TREE PROTECTION	
TEMPORARY SEEDING	
PERMANENT SEEDING	
SODDING	
RIPRAP	
OUTLET PROTECTION - RIP RAP	
SEDIMENT TRAP	
ROCK CHECK DAM	
STABILIZED CONSTRUCTION ENTRANCE	
STORM DRAIN INLET PROTECTION - TYPE A FILTER FABRIC	
STORM DRAIN INLET PROTECTION - TYPE E SURFACE COURSE CURB INLET FILTER	

## WATER LEGEND

DESCRIPTION	EXISTING	PROPOSED
WATER MAIN		
SINGLE SERVICE LATERAL		
DOUBLE SERVICE LATERAL		
VALVE AND BOX		
FIRE HYDRANT W/VALVE & BOX		
POST HYDRANT		
REDUCER		
BACKFLOW PREVENTOR		
CROSS		
TEE		
90° BEND - HORIZONTAL		
45° BEND - HORIZONTAL		
22-1/2° BEND - HORIZONTAL		
11-1/4° BEND - HORIZONTAL		
BEND - VERTICAL		
CAP		

## ABBREVIATIONS

HDPE	HIGH DENSITY POLYETHYLENE	JB	JUNCTION BOX	SDMH	STORM DRAINAGE MANHOLE
BOT	BOTTOM	LF	LINEAR FEET	SF	SQUARE FEET
CI	CURB INLET	MAX	MAXIMUM	SS	SANITARY SEWER
CPP	CORRUGATED PLASTIC PIPE	MIN	MINIMUM	TC	TOP OF CURB
DIP	DUCTILE IRON PIPE	MH	MANHOLE	TG	TOP OF GUTTER
EL	ELEVATION	OC	ON CENTER	TP	TOP OF PAVEMENT
FG	FINISH GRADE	PC	POINT OF CURVE	TW	TOP OF WALK
FH	FIRE HYDRANT	PH	POST HYDRANT	TYP	TYPICAL
FM	FORCE MAIN (SANITARY SEWER)	PT	POINT OF TANGENT	W	WATER
FP	FINISH PAD	PVC	POLYVINYL CHLORIDE	W/	WITH
FR	FRAME	RCP	REINFORCED CONCRETE PIPE	WV	WATER VALVE
GI	GRATE INLET	RJP	RESTRAINED JOINT PIPE	YI	YARD INLET
GV	GATE VALVE	R/W	RIGHT-OF-WAY		
INV	INVERT ELEVATION	SD	STORM DRAINAGE		

## OTHER UTILITIES LEGEND

DESCRIPTION	EXISTING
NATURAL GAS	
TELEPHONE	
UNDERGROUND TELEPHONE	
ELECTRICITY	
UNDERGROUND ELECTRICITY	

## GENERAL NOTES

- CONTRACTOR SHALL COORDINATE TIE-IN OF NEW WATER AND SEWER FACILITIES TO CITY OF MYRTLE BEACH WATER AND SEWER AUTHORITY
- CONTRACTOR SHALL MAINTAIN MINIMUM COVER OVER THE WATER MAIN PIPE BARREL OF 3'-0" UNLESS OTHERWISE INDICATED. TOP OF PIPE ELEVATIONS ARE SHOWN FOR CASES WHERE FUTURE STORM SEWERS ARE TO BE INSTALLED. IN NO CASE SHALL THE WATER MAIN BE INSTALLED AT A LOWER ELEVATION THAN THAT SHOWN.
- SHOULD PIPE, FITTINGS, AND OTHER MATERIALS BE NEEDED IN ADDITION TO THAT SHOWN ON THE DRAWINGS BECAUSE PIPELINE WAS NOT INSTALLED TO THE ALIGNMENT AND PROFILE SHOWN, THEN THE CONTRACTOR IS RESPONSIBLE FOR OBTAINING THOSE NECESSARY MATERIALS AND PROVIDING THE EQUIPMENT AND LABOR TO INSTALL THEM TO MEET THE DESIGN INTENT OF THE WATERMAIN AT NO ADDITIONAL COST TO THE OWNER.
- THE CONTRACTOR SHALL NOTIFY THE OWNER AND THE ENGINEER 24 HOURS IN ADVANCE OF ALL REQUIRED TESTS AND INSPECTIONS.
- THE CONTRACTOR WILL NOTIFY THE ENGINEER IF UNSUITABLE MATERIAL IS DISCOVERED PRIOR TO BEGINNING ANY REMOVAL OPERATION.
- ALL WATERMANS SHALL BE POLYVINYL CHLORIDE (PVC C900) UNLESS OTHERWISE INDICATED.
- ALL GRAVITY SEWER MAIN SHALL BE POLYVINYL CHLORIDE (PVC SDR35) UNLESS OTHERWISE INDICATED.
- SURVEYING AND BOUNDARY INFORMATION BY THOMAS AND HUTTON
- ALL ELEVATIONS SHOWN ARE BASED ON NAVD83.
- TOPOGRAPHIC SURVEY BY THOMAS AND HUTTON.
- CONTRACTOR IS TO VERIFY ACCURACY OF ANY TEMPORARY BENCHMARKS SHOWN PRIOR TO UTILIZING THEM FOR CONSTRUCTION.
- THE EXISTING UNDERGROUND UTILITIES SHOWN HEREON ARE BASED UPON AVAILABLE INFORMATION. THE CONTRACTOR SHALL BE RESPONSIBLE FOR DETERMINING THE EXACT LOCATION OF ALL UTILITIES OTHER THAN THOSE SHOWN ARE ENCOUNTERED DURING CONSTRUCTION. THE CONTRACTOR SHALL NOTIFY THE ENGINEER IMMEDIATELY AND TAKE STEPS TO PROTECT THE LINE(S) AND ENSURE CONTINUED SERVICE. DAMAGE CAUSED TO EXISTING UTILITIES BY THE CONTRACTOR SHALL BE REPAIRED BY THE CONTRACTOR. ADDITIONALLY, THE CONTRACTOR SHALL CONFIRM THE CONNECTION POINTS OF NEW UTILITIES TO EXISTING UTILITIES PRIOR TO BEGINNING NEW CONSTRUCTION.
- IF WORK IS SUSPENDED OR DELAYED FOR 14 DAYS, THE CONTRACTOR SHALL TEMPORARILY STABILIZE THE DISTURBED AREA AT NO ADDITIONAL COST TO THE OWNER.
- THE CONTRACTOR SHALL INSTALL ANY BARRICADES PRIOR TO BEGINNING CONSTRUCTION
- THE FOLLOWING NOTES ARE SPECIFIED BY THE COUNTY ENGINEER AND ARE TO BE EXECUTED BY THE CONTRACTOR FOR STREETS IN THE PROJECT WHICH ARE TO BE DEEDED TO THE COUNTY:
  - ANY DAMAGE TO EXISTING PAVEMENT MUST BE REPAIRED AT CONTRACTORS EXPENSE AND TO THE SATISFACTION OF THE COUNTY ENGINEER AND THE PROJECT ENGINEER.
  - ALL RIGHT-OF-WAY AND DRAINAGE EASEMENT CONSTRUCTION SHALL MEET SCODOT STANDARD SPECIFICATIONS UNLESS SPECIFIED ELSEWHERE AND APPROVED IN WRITING BY THE COUNTY ENGINEER.
  - ALL LOTS WITHIN THE DEVELOPMENT SHALL BE FILLED AND HAVE POSITIVE DRAINAGE TO THE APPROPRIATE EASEMENT OR RIGHT-OF-WAY AS APPROVED ON THE PLANS PRIOR TO THE ISSUANCE OF ANY BUILDING PERMITS OR FINAL ACCEPTANCE OF THE RIGHT-OF-WAYS BY THE COUNTY
  - WHERE FIELD INSPECTIONS ARE REQUIRED BY THE COUNTY, THE CONTRACTOR SHALL NOTIFY THE ENGINEERING DIVISION A MINIMUM OF 48 HOURS IN ADVANCE TO SCHEDULE SUCH INSPECTIONS.
  - A COMPLETE SET OF APPROVED DRAWINGS AND SPECIFICATIONS MUST BE MAINTAINED ON SITE AT ALL TIMES THAT THE CONTRACTOR IS PERFORMING WORK. THESE DRAWINGS SHALL BE MADE AVAILABLE UPON REQUEST.
  - ANY REVISIONS DURING CONSTRUCTION WHICH ALTER THE ROAD LAYOUT, CONSTRUCTION METHODS, RIGHT-OF-WAY LOCATION OR DRAINAGE MUST BE SUBMITTED AND APPROVED IN WRITING BY THE COUNTY ENGINEER.
- THE CONTRACTOR IS RESPONSIBLE FOR OBTAINING ALL CONSTRUCTION PERMITS NECESSARY FROM OTHER RESPONSIBLE AGENCIES.
- ALL TREES SHOWING DISTURBANCE WITHIN THE PROTECTED ROOT ZONE SHALL BE PRUNED AND FERTILIZED BY A CERTIFIED ARBORIST PRIOR TO RECEIVING FINAL PLAT APPROVAL. (THIS WORK WILL BE DONE BY THE OWNER OUTSIDE OF THE CONTRACT.)
- LAKE CONTOURS SHOWN HEREIN WILL PROVIDE A DEPTH ONE FOOT GREATER THAN NECESSARY FOR STORM WATER MANAGEMENT. THIS IS TO PROVIDE FOR ONE FOOT OF SILT BUILDUP DURING CONSTRUCTION OF ANY AREA OF ANY POND WHICH SILTS MORE THAN ONE FOOT ABOVE DESIGNED BOTTOM ELEVATION SHALL BE RESTORED TO THE MINIMUM ACCEPTABLE DEPTH OF ONE FOOT LESS THAN ORIGINAL CONSTRUCTED DEPTH.
- ALL ABOVE GROUND UTILITIES ARE TO BE OUTSIDE OF THE R/W AND ALL AT GRADE UTILITIES ARE TO BE OUT OF THE CURB LINE.
- THE CONTRACTOR SHALL INSTALL ALL EROSION CONTROL AND PREVENTION STRUCTURES SHOWN ON THE PLANS. BOTH MUST BE APPROVED BY Horry COUNTY PRIOR TO BEGINNING ANY LAND DISTURBING ACTIVITIES.
- THE CONTRACTOR SHALL NOTIFY THE ENGINEER IF UNSUITABLE MATERIAL IS DISCOVERED PRIOR TO BEGINNING ANY REMOVAL OPERATION.
- CONTRACTOR WILL BE REQUIRED TO ADJUST MANHOLE FRAMES TO MATCH FINAL GRADE AT NO ADDITIONAL COST.
- THE FOLLOWING NOTES ARE SPECIFIED BY THE SOUTH CAROLINA DEPARTMENT OF HEALTH AND ENVIRONMENTAL CONTROL - OFFICE OF OCEAN AND COASTAL RESOURCES MANAGEMENT (SCDHEC-OCRM) AND ARE TO BE EXECUTED BY THE CONTRACTOR:
  - ALL SEDIMENT CONTROL MEASURES SHALL BE INSPECTED AT LEAST ONCE EVERY SEVEN CALENDAR DAYS AND AFTER ANY STORM EVENT OF GREATER THAN 0.5 INCHES OF PRECIPITATION DURING ANY 24-HOUR PERIOD. ALL SEDIMENT CONTROL FEATURES SHALL BE MAINTAINED UNTIL FINAL STABILIZATION HAS BEEN OBTAINED.
  - STABILIZATION MEASURES SHALL BE INITIATED AS SOON AS PRACTICABLE IN PORTIONS OF THE SITE WHERE CONSTRUCTION ACTIVITIES HAVE TEMPORARILY OR PERMANENTLY CEASED, BUT IN NO CASE MORE THAN 14 DAYS AFTER THE CONSTRUCTION ACTIVITY IN THAT PORTION OF THE SITE HAS TEMPORARILY OR PERMANENTLY CEASED, UNLESS ACTIVITY IN THAT PORTION OF THE SITE WILL RESUME WITHIN 14 DAYS.
  - RESIDENTIAL SUBDIVISIONS REQUIRE EROSION CONTROL FEATURES FOR INFRASTRUCTURE AS WELL AS FOR INDIVIDUAL LOT CONSTRUCTION. INDIVIDUAL PROPERTY OWNERS SHALL FOLLOW THESE PLANS DURING LOT CONSTRUCTION OR PROVIDE AN INDIVIDUAL PLAN MEETING SECTION R.72-307 OF THE STORM WATER MANAGEMENT AND SEDIMENT REDUCTION ACT REQUIREMENTS.
  - ALL EROSION AND SEDIMENT CONTROL DEVICES SHALL BE CONSTRUCTED SIMULTANEOUSLY WITH THE DISTURBANCE OF THE LAND AND SHALL REMAIN FUNCTIONAL UNTIL THE CONTRIBUTING DISTURBED AREAS ARE STABILIZED. SILT BARRIERS WILL BE INSTALLED AS NECESSARY TO PREVENT EXCESSIVE SEDIMENTATION OF DOWNSTREAM AREAS. DEVICES SHALL BE IN ACCORDANCE WITH THE MANUAL OF "EROSION AND SEDIMENT CONTROL PRACTICES FOR DEVELOPING AREAS" BY THE S.C. LAND RESOURCES CONSERVATION COMMISSION.
- CONTRACTOR SHALL GRADE AREAS TO DRAIN FOR POSITIVE FLOW PRIOR TO FINAL APPROVAL.
- ALL TRAFFIC CONTROL SIGNS AND PAVEMENT MARKINGS SHALL BE IN ACCORDANCE WITH THE MANUAL ON "UNIFORM TRAFFIC CONTROL DEVICES FOR STREETS AND HIGHWAYS" AND "SOUTH CAROLINA MANUAL ON UNIFORM TRAFFIC CONTROL DEVICES" BOTH CURRENT EDITIONS.
- ALL AREAS DISTURBED WILL BE GRASSED IMMEDIATELY AFTER THE INSTALLATION. GRASSING SHALL BE IN ACCORDANCE WITH SECTION 810 OF THE SCODOT STANDARD SPECIFICATIONS FOR HIGHWAY CONSTRUCTION CURRENT EDITION. PAYMENT SHALL BE AS SHOWN IN THE BID FORM AND SHALL BE COMPENSATION FOR ALL NECESSARY WORK AND MATERIALS TO COMPLETE THE SEEDING IN ACCORDANCE WITH THESE SPECIFICATIONS. (SEE SPECIFICATIONS BELOW)
- ALL DRAINAGE WILL BE MADE FUNCTIONAL DAILY AS WORK PROGRESSES.
- EACH EXISTING ROAD WILL BE CLEANED UP AND RESTORED DAILY.
- NEW PAVEMENT TO BE FLUSH WITH EDGE OF EXISTING PAVEMENT.
- ALL STORM DRAIN PIPE INVERTS IN AND OUT ARE THE SAME AS THE BOX INVERT UNLESS OTHERWISE NOTED ON THE PLAN SHEETS AND/OR PROFILES.
- ALL SEWER VALVES SHALL COMPLY WITH THE CITY OF MYRTLE BEACH SEWER SYSTEM STANDARDS AND SPECIFICATIONS.
- ALL WATER VALVES SHALL COMPLY WITH THE CITY OF MYRTLE BEACH WATER SYSTEM STANDARDS AND SPECIFICATIONS.
- ONLY TYPE S AND M MORTAR IS TO BE USED IN STORMWATER SYSTEM CONSTRUCTION AND ALL BRICKWORK AND BRICK MUST MEET SCODOT SPECIFICATIONS.
- THE DESIGN OF THE PAVEMENT AND EARTHWORK MATERIALS, PROCEDURES AND METHODS SPECIFIED ARE BASED ON THE CRITERIA AND RECOMMENDATIONS ESTABLISHED IN THE GEOTECHNICAL INVESTIGATION REPORT PREPARED BY S & ME INC., DATED DECEMBER 19, 2019 AND SUBSEQUENT ADDENDUMS.
- THE POSTED SPEED LIMIT FOR PAMPAS DRIVE, SWALLOW AVENUE, HEMLOCK AVENUE AND CACTUS STREET IS 30 M.P.H.

PREPARED FOR:  
**HORRY GEORGETOWN  
 TECHNICAL COLLEGE**  
 2050 EAST HIGHWAY 501  
 CONWAY, SC 29526

COUNTY HORRY COUNTY  
 TOWN MYRTLE BEACH CITY  
 ZONING P.U.D. ZONE

OWNER:  
 HORRY GEORGETOWN TECHNICAL COLLEGE  
 2050 EAST HIGHWAY 501  
 CONWAY, SC 29526

SURVEYOR:  
 THOMAS & HUTTON  
 50 PARK OF COMMERCE WAY  
 SAVANNAH, GA 31405  
 (912) 234-5300

UTILITY:  
 CITY OF MYRTLE BEACH WATER & SEWER AUTHORITY  
 921 OAK STREET  
 MYRTLE BEACH, SC 29578  
 843-918-1212

## DRAINAGE LEGEND

DESCRIPTION	EXISTING	PROPOSED
PIPE		
DITCH		
CURB INLET		
GRATE INLET		
JUNCTION BOX		
OUTLET STRUCTURE		

## SEWER LEGEND

DESCRIPTION	EXISTING	PROPOSED
GRAVITY PIPE		
SINGLE SERVICE LATERAL		
DOUBLE SERVICE LATERAL		
MANHOLE		
CLEANOUT		
FORCEMAIN		
VALVE AND BOX		
FLUSH HYDRANT		
REDUCER		
BACKFLOW PREVENTOR		
CROSS		
TEE		
90° BEND - HORIZONTAL		
45° BEND - HORIZONTAL		
22-1/2° BEND - HORIZONTAL		
11-1/4° BEND - HORIZONTAL		
BEND - VERTICAL		
PLUG \ CAP		

**BECKER  
 MORGAN  
 GROUP**

ARCHITECTURE  
 PLANNING

North Carolina  
 3333 Jaekle Drive, Suite 120  
 Wilmington, NC 28403  
 910.341.7600

Maryland  
 312 West Main St, Suite 300  
 Salisbury, MD 21801  
 410.546.9100

Delaware  
 309 S Governors Ave  
 Dover, DE 19904  
 302.734.7950

Rittenhouse Station  
 250 South Main Street, Suite 109  
 Newark, DE 19711  
 302.369.3700  
 www.beckermorgan.com

**THOMAS  
 & HUTTON**

611 Burroughs & Chapin Blvd. • Suite 202  
 Myrtle Beach, SC 29577 • 843.839.3545

www.thomasandhutton.com

**WACCAMAW  
 LANDSCAPING**  
 AND CONSTRUCTION  
 PAWLEYS ISLAND, S.C.

P.O. Box 213 • 1066 Petigru Dr.  
 Pawleys Island, SC 29585 • 843-237-2224  
 www.waccamawlandscaping.com

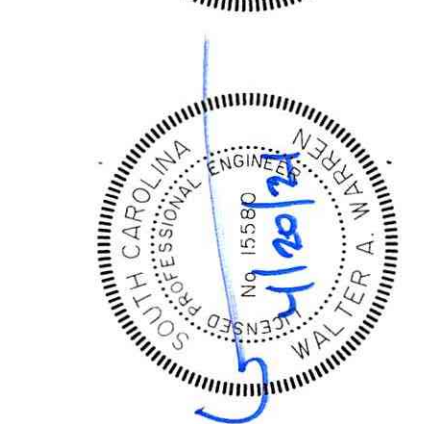
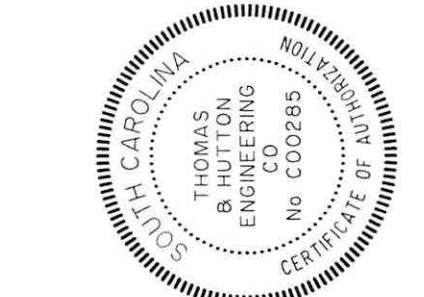

PROJECT TITLE

HGTC - GRAND STRAND  
 LANDSCAPING AND  
 IRRIGATION

743 HEMLOCK AVENUE  
 MYRTLE BEACH, SC 29577

S.C. OSC PROJECT NUMBER:  
 H59-N035-MJ

SHEET TITLE

GENERAL NOTES  
 AND INDEX

ISSUE BLOCK

No.	Date	Description
0	04/19/21	ISSUED FOR BID

PROJECT NO: J - 27742.0002

DATE: 04/19/2021

SCALE: N/A

DRAWN BY: JJK PROJ MGR: WAW

**G1.1**

COPYRIGHT © 2019

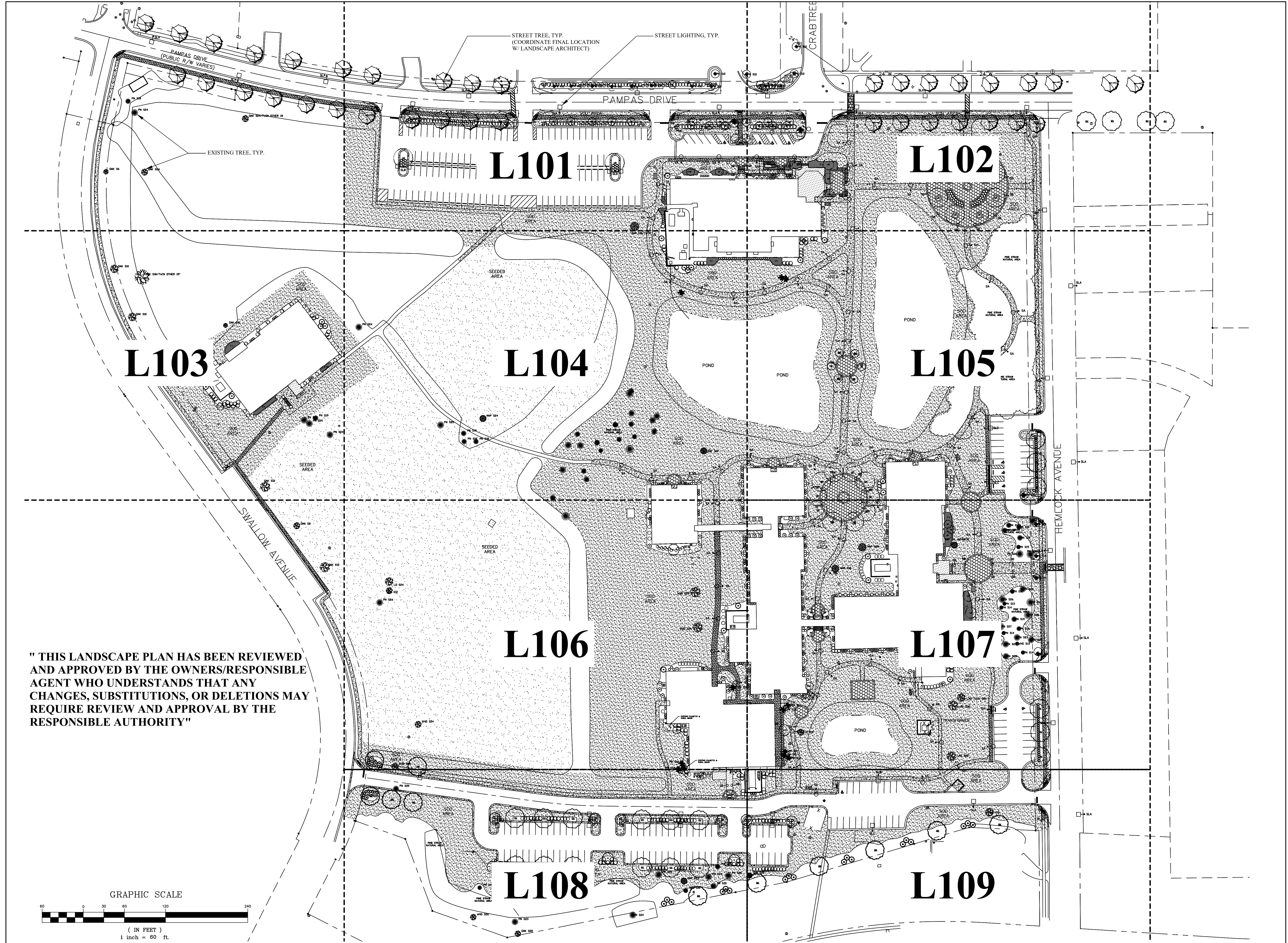

" THIS LANDSCAPE PLAN HAS BEEN REVIEWED AND APPROVED BY THE OWNERS/RESPONSIBLE AGENT WHO UNDERSTANDS THAT ANY CHANGES, SUBSTITUTIONS, OR DELETIONS MAY REQUIRE REVIEW AND APPROVAL BY THE RESPONSIBLE AUTHORITY"

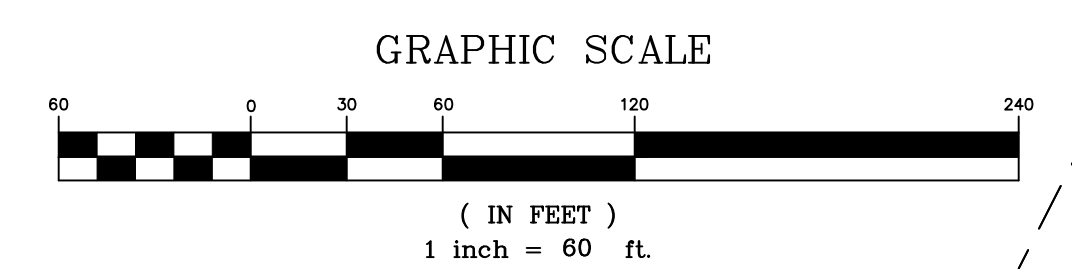

ARCHITECTURE  
PLANNING

North Carolina  
 3333 Jaeckle Drive, Suite 120  
 Wilmington, NC 28403  
 910.341.7600

Maryland  
 312 West Main St, Suite 300  
 Salisbury, MD 21801  
 410.546.9100

Delaware  
 309 S Governors Ave  
 Dover, DE 19904  
 302.734.7950

Rittenhouse Station  
 250 South Main Street, Suite 109  
 Newark, DE 19711  
 302.369.3700  
 www.beckermorgan.com



611 Burroughs & Chapin Blvd. • Suite 202  
 Myrtle Beach, SC 29577 • 843.839.3545  
 www.thomasandhutton.com

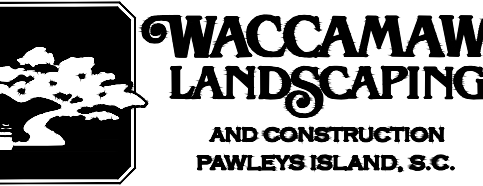

P.O. Box 213 • 1066 Petigru Dr.  
 Pawleys Island, SC 29585 • 843-237-2224  
 www.waccamawlandscaping.com

PROJECT TITLE  
 HGTC - GRAND STRAND  
 LANDSCAPING AND  
 IRRIGATION

743 HEMLOCK AVENUE  
 MYRTLE BEACH, SC 29577

S. C. OSC PROJECT NUMBER:  
 H59-N035-MJ

SHEET TITLE  
 OVERALL  
 LANDSCAPE PLAN

Mark	Date	Description
1	12/10/20	VE REVISIONS
2	01/14/21	OWNER COMMENTS
3	02/05/21	CITY COMMENTS
4	03/01/21	STREET TREE REVISIONS
5	04/02/21	ISSUED FOR BID
6	04/20/21	OSE COMMENTS

PROJECT NO: J - 27742.0002  
 DATE: 04/19/2021  
 SCALE: N/A  
 DRAWN BY: MGM | PROJ MGR: JCR

L100  
 COPYRIGHT © 2019

**PLANT MATERIAL KEY**

- QV LIVE OAK
- LI CRAPE MYRTLE
- QW NUTTALL OAK
- SP PALMETTO
- UP CHINESE ELM
- LIN NATCHEZ CRAPE MYRTLE
- QA WHITE OAK
- LD LONDON PLANE TREE
- IL NELLIE R STEVENS HOLLY
- GP EUROPEAN FAN PALM
- POD PODOCARPUS
- LIG LIGUSTRUM
- SUN SUNSHINE LIGUSTRUM
- BOX BOXWOOD
- DWP DWARF PALMETTO
- SAP SAW PALMETTO
- DYH DWARF YAUPON HOLLY
- SSA SPREADING SASANQUA
- PLY PLUM YEW
- SCM SOFT CARESS MAHONIA
- BGR BREEZE GRASS
- AJ ASIATIC JASMINE
- ANN ANNUALS
- CF CREEPING FIG

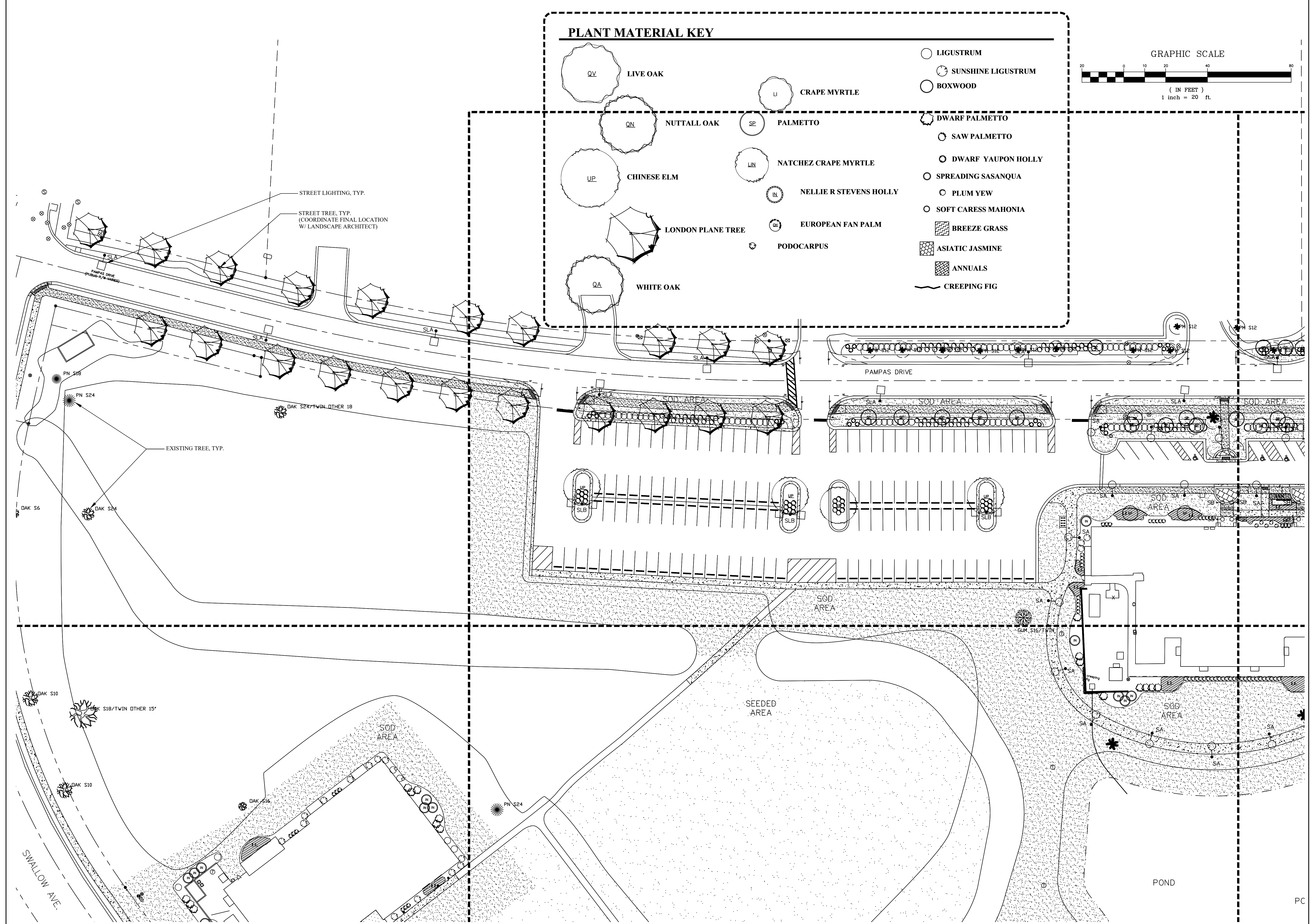
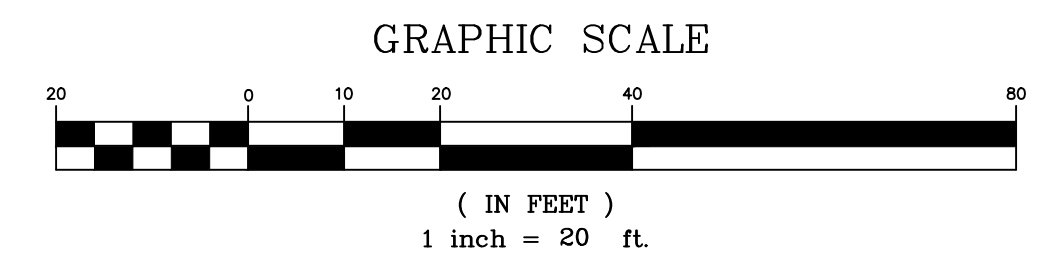

PROJECT TITLE  
**HGTC - GRAND STRAND  
LANDSCAPING AND  
IRRIGATION**

743 HEMLOCK AVENUE  
MYRTLE BEACH, SC 29577

S.C. OSC PROJECT NUMBER:  
H59-N035-MJ

SHEET TITLE  
**PLANTING  
PLAN**

ISSUE BLOCK

Mark	Date	Description
1	12/10/20	VE REVISIONS
2	01/14/21	OWNER COMMENTS
3	02/05/21	CITY COMMENTS
4	03/01/21	STREET TREE REVISIONS
5	04/02/21	ISSUED FOR BID
6	04/20/21	OSE COMMENTS

PROJECT NO: **J - 27742.0002**  
DATE: **04/19/2021**  
SCALE: 1" = 20'  
DRAWN BY: MGM | PROJ MGR: JCR





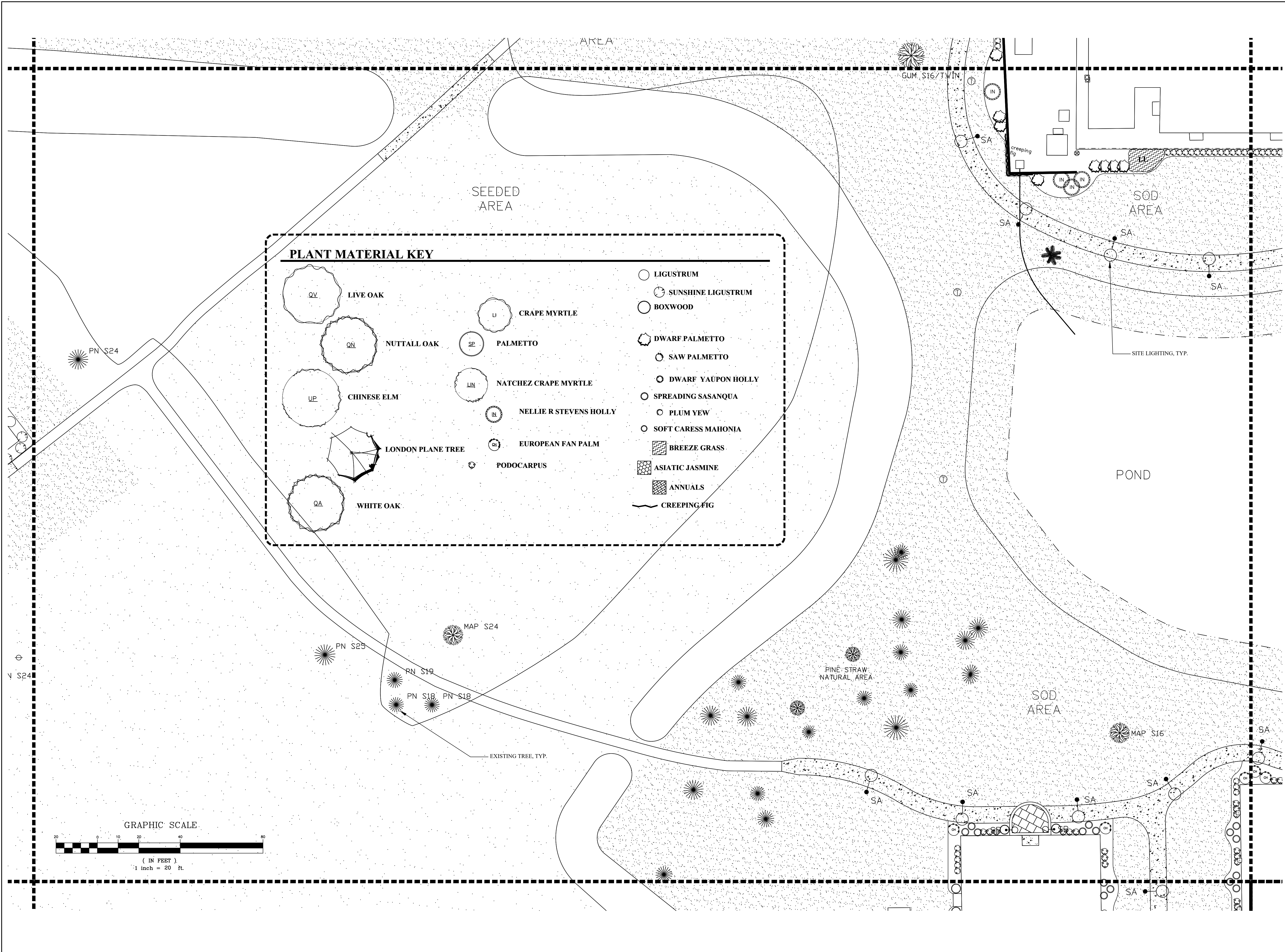

PROJECT TITLE  
**HGTC - GRAND STRAND  
LANDSCAPING AND  
IRRIGATION**

743 HEMLOCK AVENUE  
MYRTLE BEACH, SC 29577

S.C. OSC PROJECT NUMBER:  
H59-N035-MJ

SHEET TITLE  
**PLANTING  
PLAN**

Mark	Date	Description
16	04/20/21	OSE COMMENTS
15	04/02/21	ISSUED FOR BID
14	03/01/21	STREET TREE REVISIONS
13	02/05/21	CITY COMMENTS
2	01/14/21	OWNER COMMENTS
	12/10/20	VE REVISIONS

PROJECT NO: **J - 27742.0002**  
DATE: **04/19/2021**  
SCALE: **1" = 20'**  
DRAWN BY: **MGM** | PROJ MGR: **JCR**

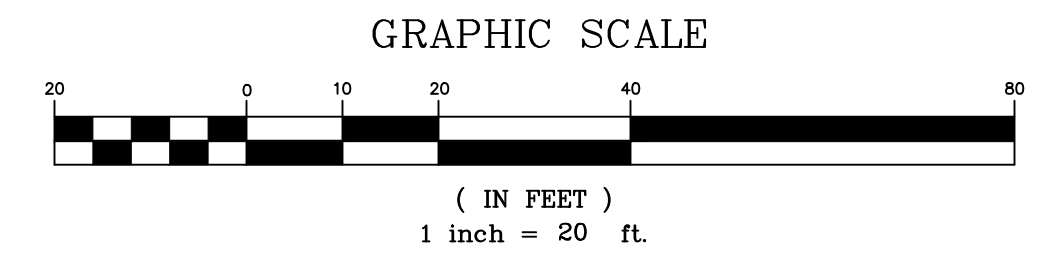
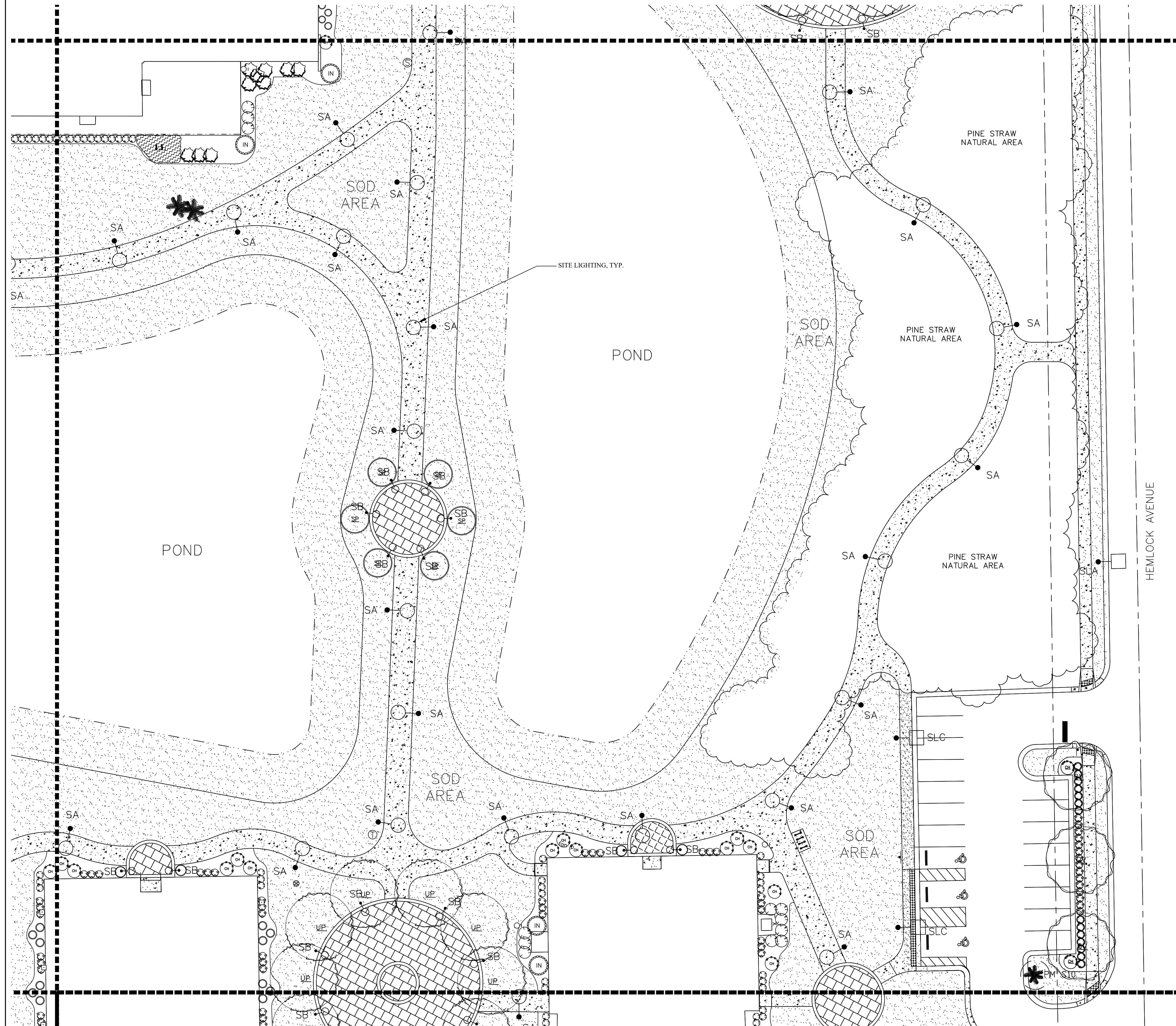

**PLANT MATERIAL KEY**

	LIVE OAK
	NUTTALL OAK
	CHINESE ELM
	LONDON PLANE TREE
	WHITE OAK
	CRAPE MYRTLE
	PALMETTO
	NATCHEZ CRAPE MYRTLE
	NELLIE R STEVENS HOLLY
	EUROPEAN FAN PALM
	PODOCARPUS
	LIGUSTRUM
	SUNSHINE LIGUSTRUM
	BOXWOOD
	DWARF PALMETTO
	SAW PALMETTO
	DWARF YAUPON HOLLY
	SPREADING SASANQUA
	PLUM YEW
	SOFT CARESS MAHONIA
	BREEZE GRASS
	ASIATIC JASMINE
	ANNUALS
	CREEPING FIG



ARCHITECTURE  
PLANNING

North Carolina  
3333 Jaeckle Drive, Suite 120  
Wilmington, NC 28403  
910.341.7600

Maryland  
312 West Main St., Suite 300  
Salisbury, MD 21801  
410.546.9100

Delaware  
309 S Governors Ave  
Dover, DE 19904  
302.734.7950

Rittenhouse Station  
250 South Main Street, Suite 109  
Newark, DE 19711  
302.369.3700  
www.beckermorgan.com

**THOMAS & HUTTON**

611 Burroughs & Chapin Blvd. • Suite 202  
Myrtle Beach, SC 29577 • 843.839.3545  
www.thomasandhutton.com

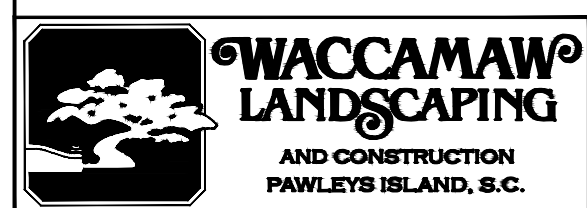

P.O. Box 213 • 1066 Petigru Dr.  
Pawleys Island, SC 29585 • 843-237-2224  
www.waccamawlandscaping.com

PROJECT TITLE  
**HGTC - GRAND STRAND  
 LANDSCAPING AND  
 IRRIGATION**

743 HEMLOCK AVENUE  
 MYRTLE BEACH, SC 29577

S.C. OSC PROJECT NUMBER:  
 H59-N035-MJ

SHEET TITLE  
**PLANTING  
 PLAN**

ISSUE BLOCK

Mark	Date	Description
16	04/20/21	OSE COMMENTS
15	04/02/21	ISSUED FOR BID
14	03/01/21	STREET TREE REVISIONS
13	02/05/21	CITY COMMENTS
12	01/14/21	OWNER COMMENTS
	12/10/20	VE REVISIONS

PROJECT NO: **J - 27742.0002**  
 DATE: **04/19/2021**  
 SCALE: **1" = 20'**  
 DRAWN BY: **MGM** | PROJ MGR: **JCR**

**L105**  
 COPYRIGHT © 2019



PROJECT TITLE  
**HGTC - GRAND STRAND  
LANDSCAPING AND  
IRRIGATION**

743 HEMLOCK AVENUE  
MYRTLE BEACH, SC 29577

S.C. OSC PROJECT NUMBER:  
H59-N035-MJ

SHEET TITLE  
**PLANTING  
PLAN**

Mark	Date	Description
6	04/20/21	OSE COMMENTS
5	04/02/21	ISSUED FOR BID
4	03/01/21	STREET TREE REVISIONS
3	02/05/21	CITY COMMENTS
2	01/14/21	OWNER COMMENTS
	12/10/20	VE REVISIONS

PROJECT NO: **J - 27742.0002**  
DATE: **04/19/2021**  
SCALE: **1" = 20'**  
DRAWN BY: **MGM** | PROJ MGR: **JCR**

**L106**

COPYRIGHT © 2019

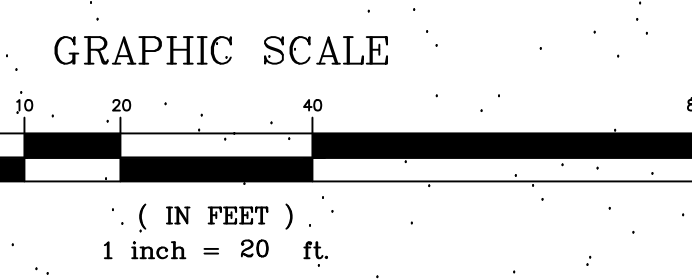
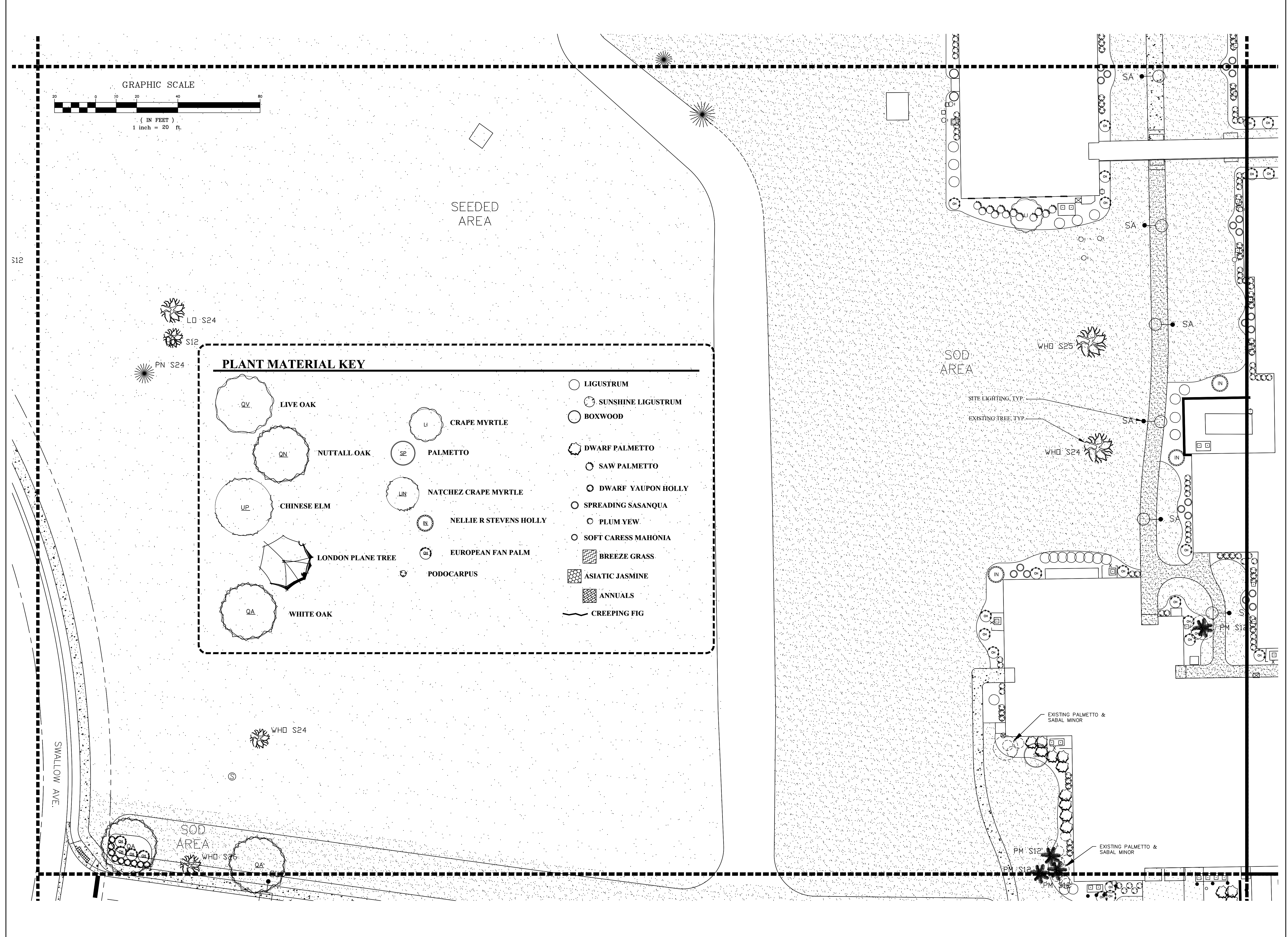

**PLANT MATERIAL KEY**

	<b>LIVE OAK</b>		<b>LIGUSTRUM</b>
	<b>NUTTALL OAK</b>		<b>SUNSHINE LIGUSTRUM</b>
	<b>CHINESE ELM</b>		<b>BOXWOOD</b>
	<b>LONDON PLANE TREE</b>		<b>DWARF PALMETTO</b>
	<b>WHITE OAK</b>		<b>SAW PALMETTO</b>
	<b>CRAPE MYRTLE</b>		<b>DWARF YAUPON HOLLY</b>
	<b>PALMETTO</b>		<b>SPREADING SASANQUA</b>
	<b>NATCHEZ CRAPE MYRTLE</b>		<b>PLUM YEW</b>
	<b>NELLIE R STEVENS HOLLY</b>		<b>SOFT CARESS MAHONIA</b>
	<b>EUROPEAN FAN PALM</b>		<b>BREEZE GRASS</b>
	<b>PODOCARPUS</b>		<b>ASIATIC JASMINE</b>
			<b>ANNUALS</b>
			<b>CREEPING FIG</b>

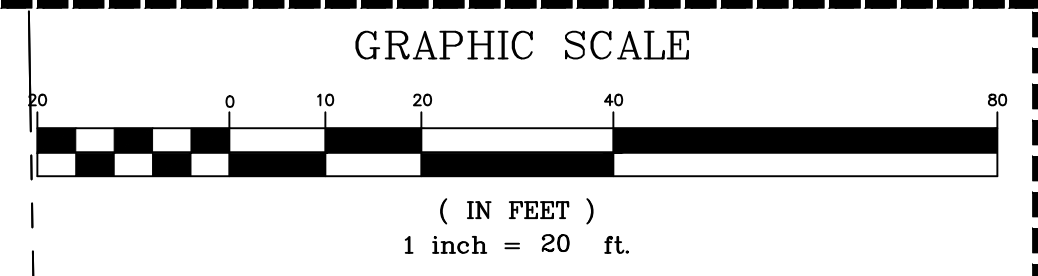
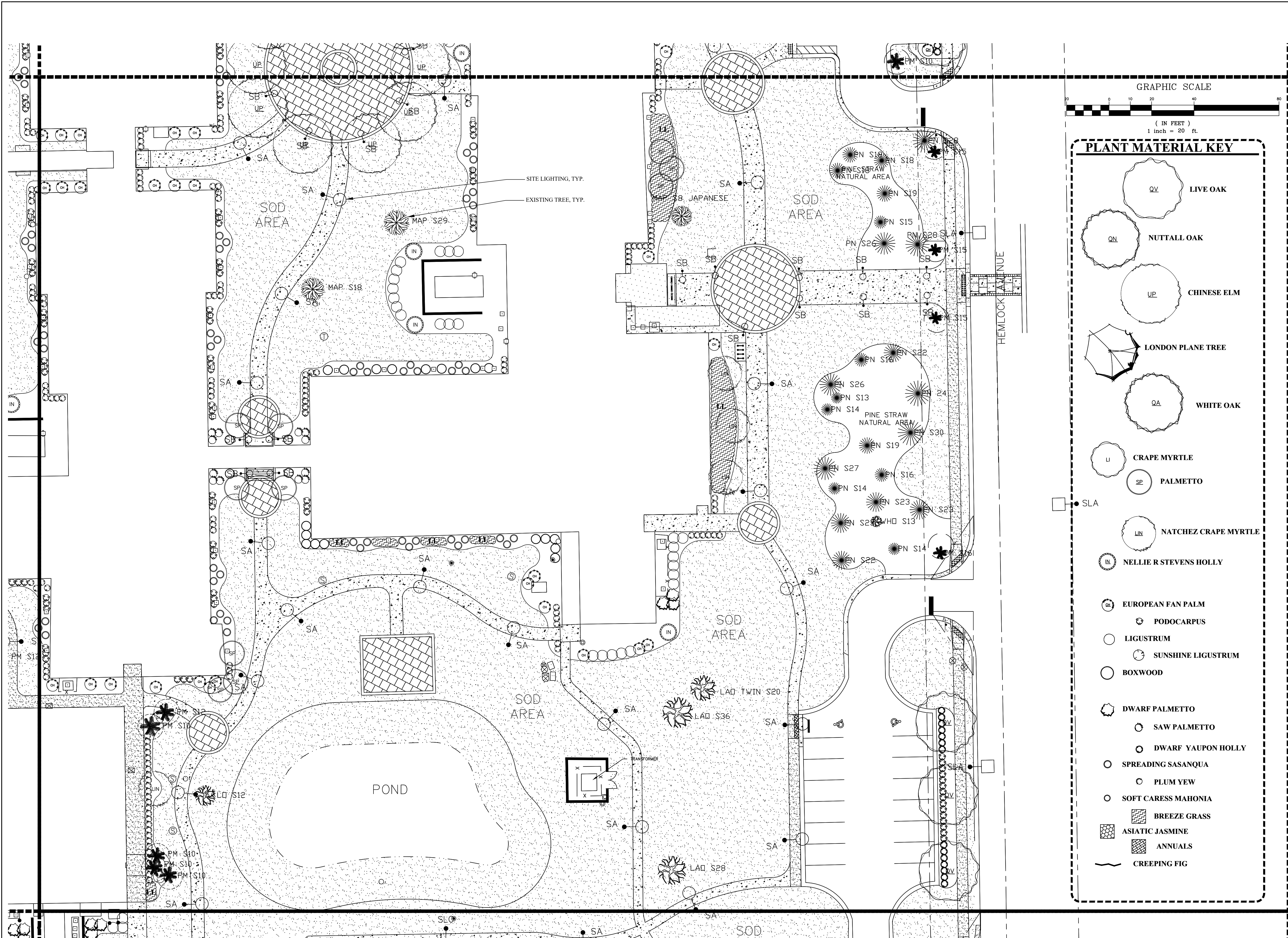

PLANT MATERIAL KEY	
	LIVE OAK
	NUTTALL OAK
	CHINESE ELM
	LONDON PLANE TREE
	WHITE OAK
	CRAPE MYRTLE
	PALMETTO
	NATCHEZ CRAPE MYRTLE
	NELLIE R STEVENS HOLLY
	EUROPEAN FAN PALM
	PODOCARPUS
	LIGUSTRUM
	SUNSHINE LIGUSTRUM
	BOXWOOD
	DWARF PALMETTO
	SAW PALMETTO
	DWARF YAUPON HOLLY
	SPREADING SASANQUA
	PLUM YEW
	SOFT CARESS MAHONIA
	BREEZE GRASS
	ASIATIC JASMINE
	ANNUALS
	CREEPING FIG

PROJECT TITLE  
**HGTC - GRAND STRAND LANDSCAPING AND IRRIGATION**

743 HEMLOCK AVENUE  
 MYRTLE BEACH, SC 29577

S.C. OSC PROJECT NUMBER:  
 H59-N035-MJ

SHEET TITLE  
**PLANTING PLAN**

Mark	Date	Description
16	04/20/21	OSE COMMENTS
15	04/02/21	ISSUED FOR BID
14	03/01/21	STREET TREE REVISIONS
13	02/05/21	CITY COMMENTS
12	01/14/21	OWNER COMMENTS
11	12/10/20	VE REVISIONS

PROJECT NO: **J - 27742.0002**  
 DATE: **04/19/2021**  
 SCALE: **1" = 20'**  
 DRAWN BY: **MGM** | PROJ MGR: **JCR**

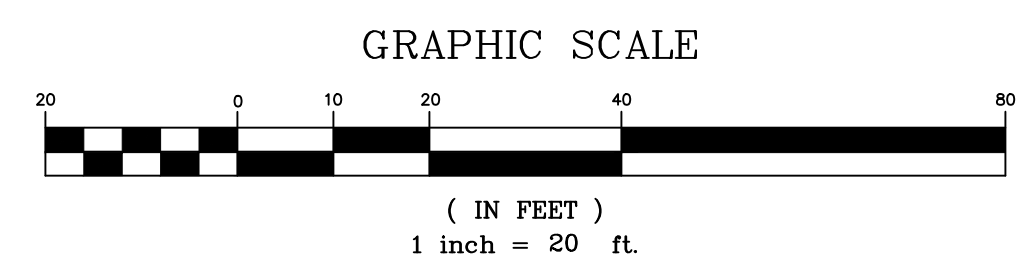
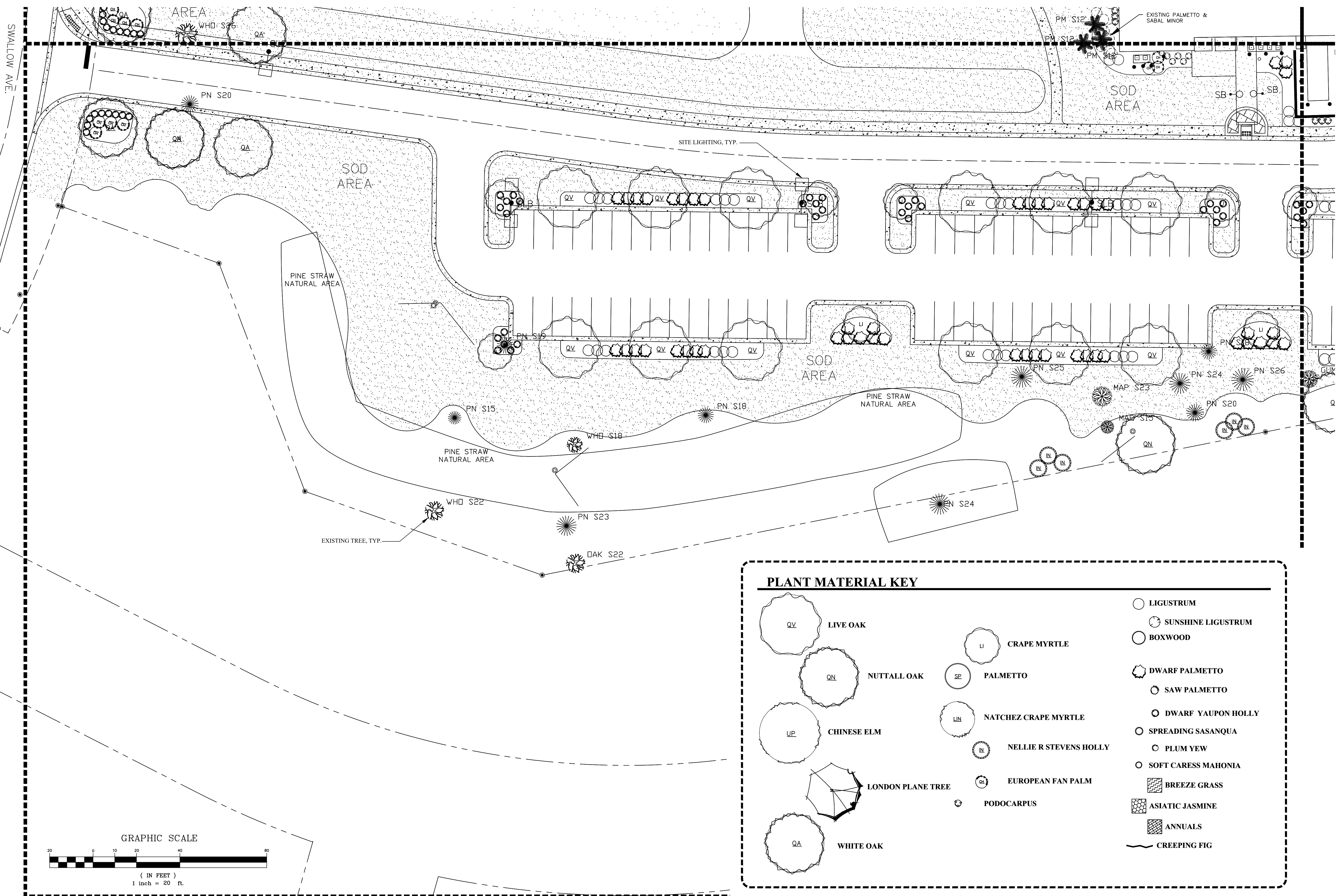

**PLANT MATERIAL KEY**

LIVE OAK	CRAPE MYRTLE	LIGURSTRUM
NUTTALL OAK	PALMETTO	SUNSHINE LIGURSTRUM
CHINESE ELM	NATCHEZ CRAPE MYRTLE	BOXWOOD
LONDON PLANE TREE	NELLIE R STEVENS HOLLY	DWARF PALMETTO
WHITE OAK	EUROPEAN FAN PALM	SAW PALMETTO
	PODOCARPUS	DWARF YAUPON HOLLY
		SPREADING SASANQUA
		PLUM YEW
		SOFT CARESS MAHONIA
		BREEZE GRASS
		ASIATIC JASMINE
		ANNUALS
		CREEPING FIG

Mark	Date	Description
6	04/20/21	OSE COMMENTS
5	04/02/21	ISSUED FOR BID
4	03/01/21	STREET TREE REVISIONS
3	02/05/21	CITY COMMENTS
2	01/14/21	OWNER COMMENTS
	12/10/20	VE REVISIONS



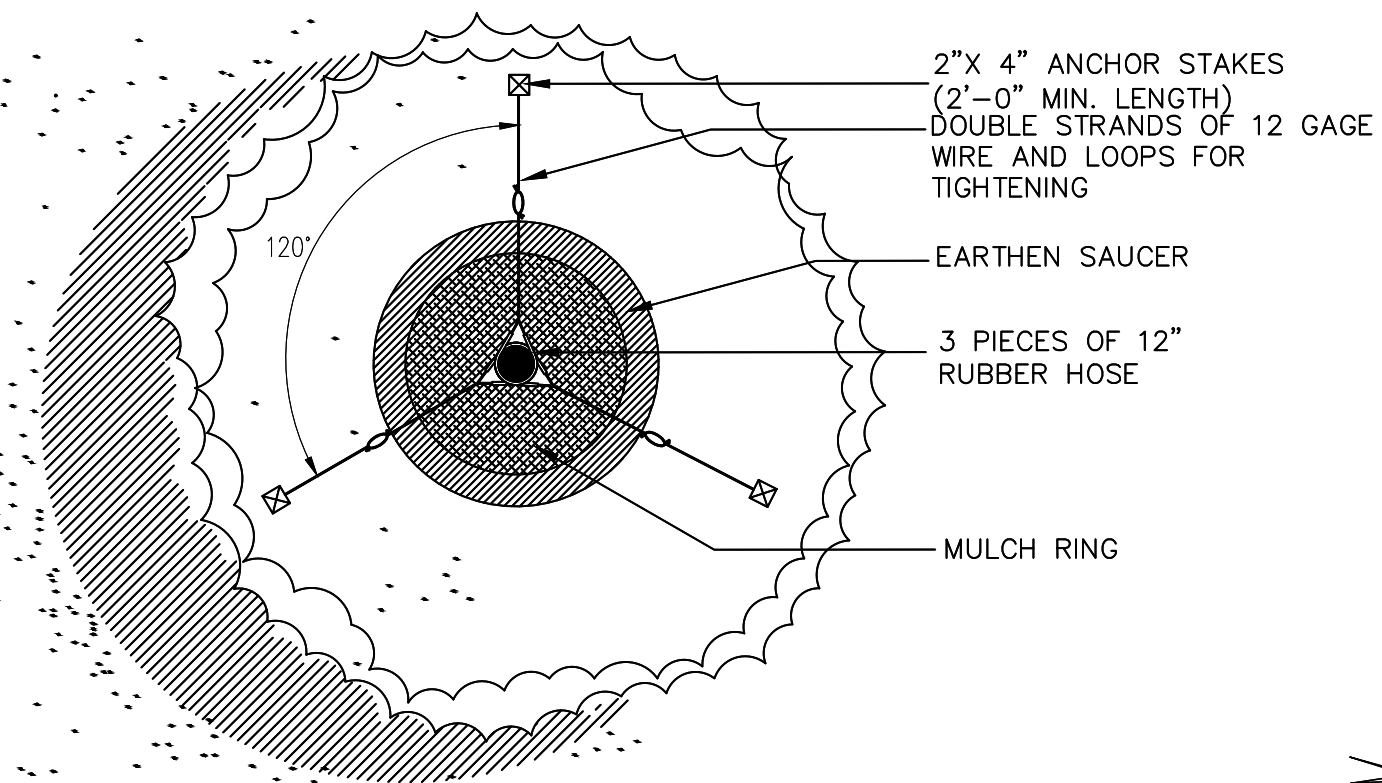

PLAN VIEW/STAKING DETAIL NO. 1  
NO SCALE

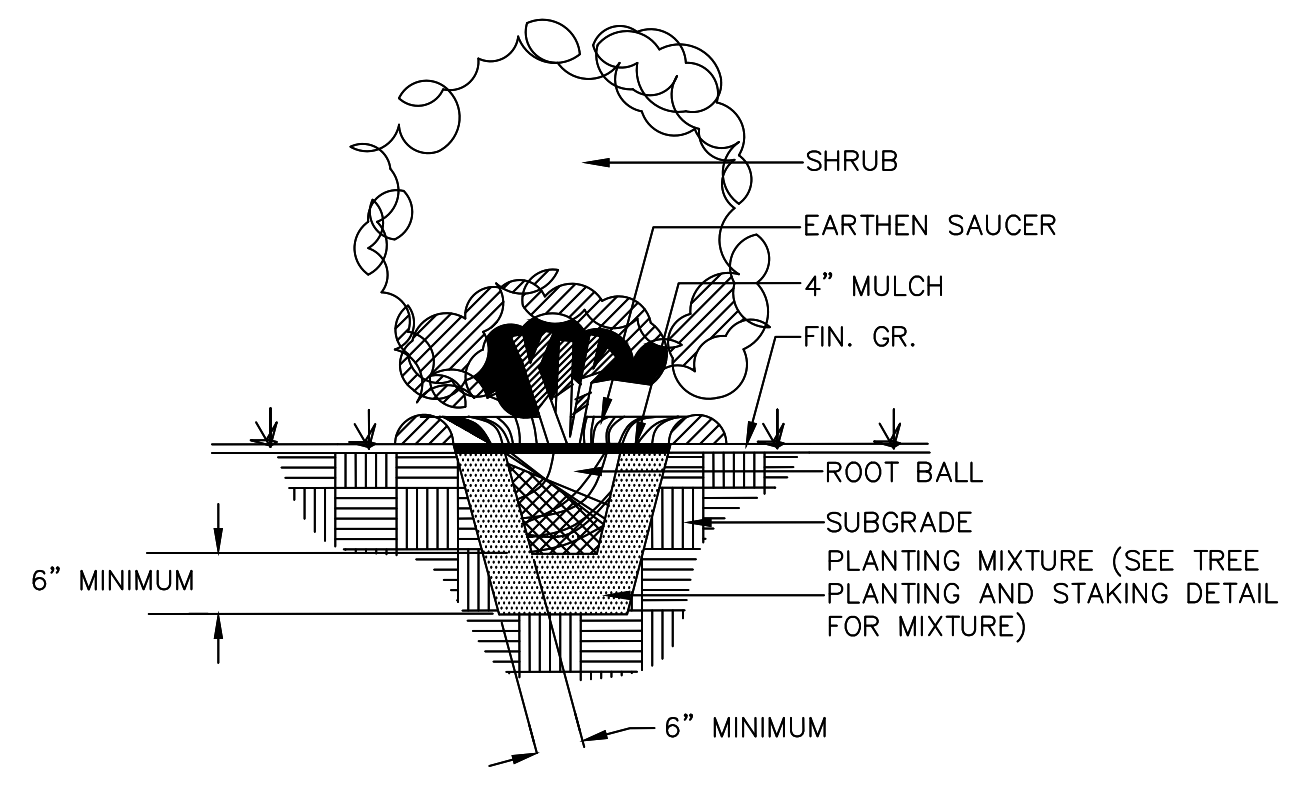

SHRUB PLANTING DETAIL  
NO SCALE

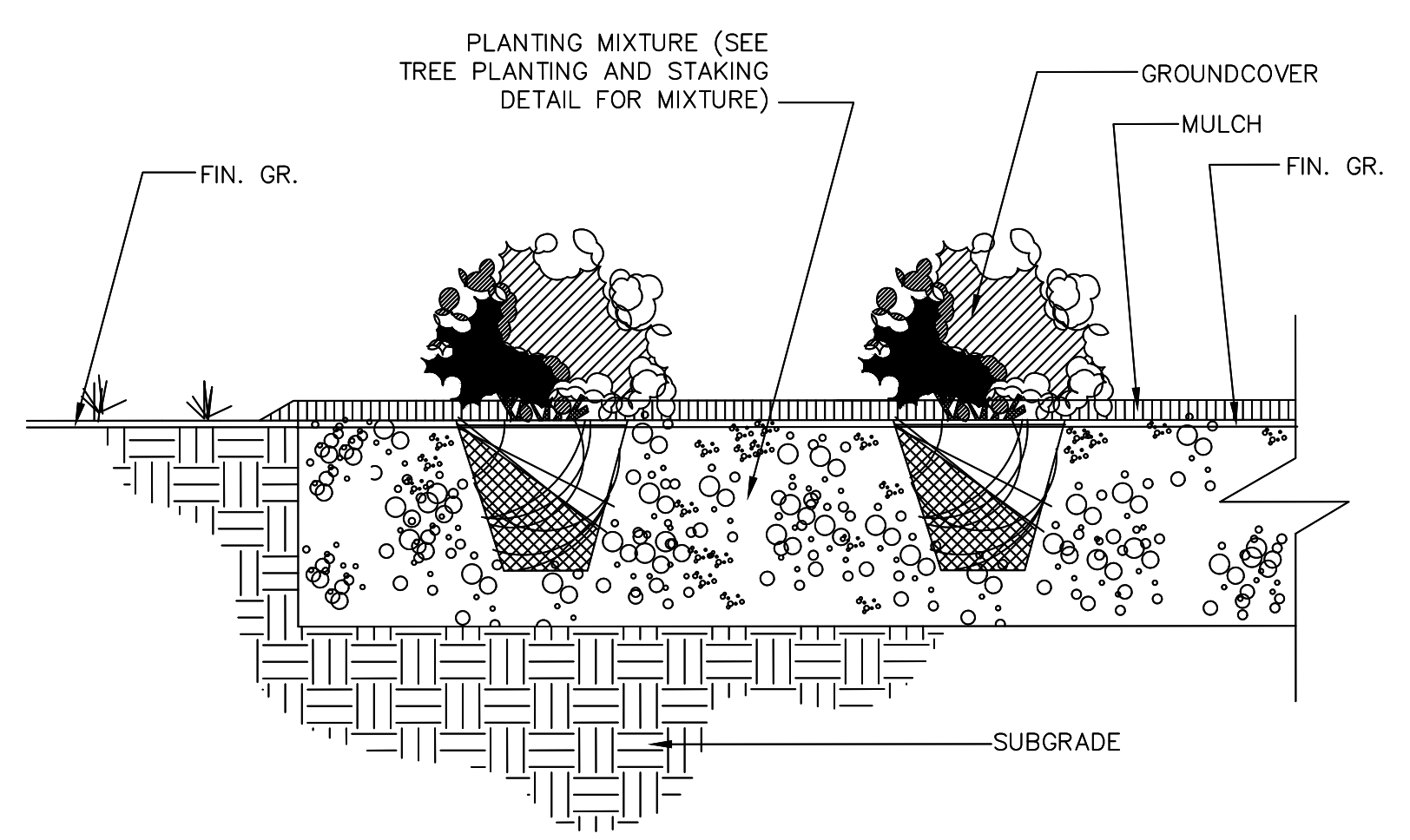

GROUND COVER PLANTING DETAIL  
NO SCALE

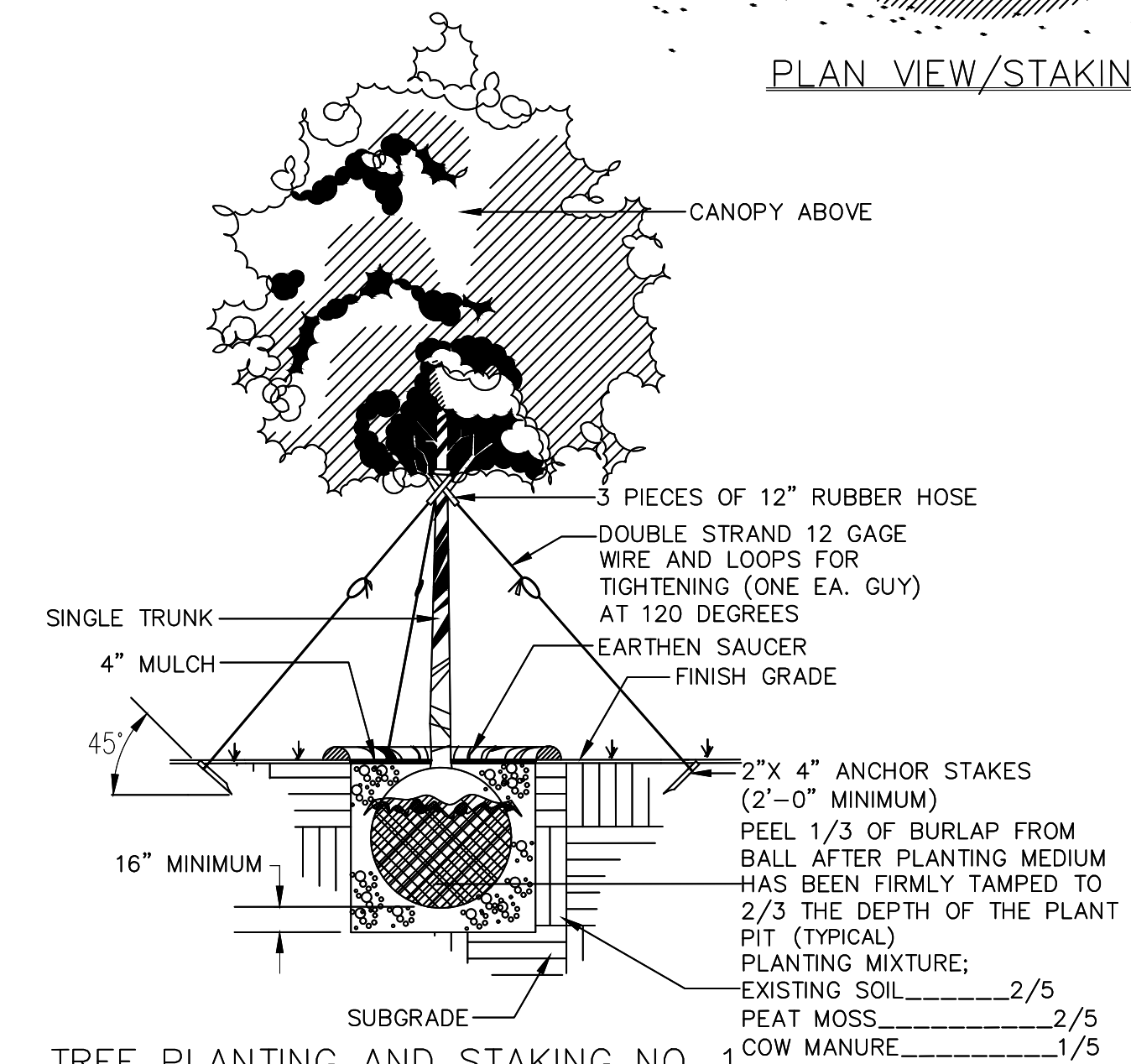

TREE PLANTING AND STAKING NO. 1  
NO SCALE

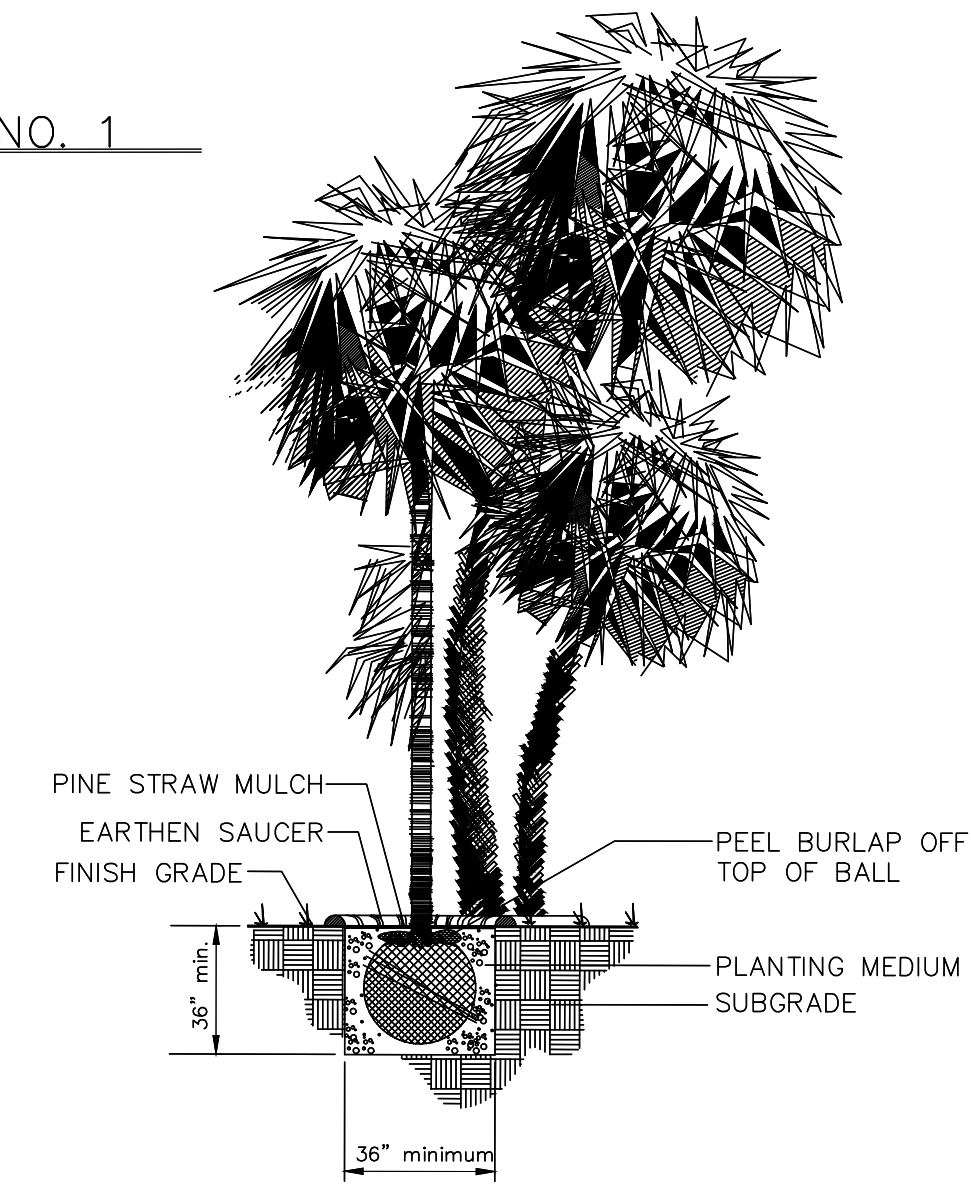

PALMETTO PLANTING DETAIL  
NO SCALE

PLANT SCHEDULE

Key	Common Name	Botanical Name	SIZE	QUANTITY	Comments/ Remarks
QV	Live Oak	<i>Quercus virginiana</i>	5" caliper, 12'-14' ht.	29	11 Street Trees
QN	Nuttall Oak	<i>Quercus nuttalli</i>	5" caliper, 12'-14' ht.	6	
QA	White Oak	<i>Quercus alba</i>	5" caliper, 12'-14' ht.	5	
	London Plane Tree	<i>Platanus x acerifolia</i>	5" caliper, 12'-14' ht.	37	Street Trees
UP	Chinese Elm	<i>Ulmus parvifolia</i>	5" caliper, 12'-14' ht.	22	
LI	Grape Myrtle - Tuscarora	<i>Lagerstroemia indica 'Tuscarora'</i>	50 gallon, 7'-8' ht.	10	3 - 5 trunks
SP	Palmetto	<i>Sabal palmetto</i>	10' - 14' ht.	46	Mix 50% booted; 13 Street Trees
LC	Tree Form Loropetalum	<i>Loropetalum chinense 'Zhuzhou'</i>	7' - 8' ht.	9	
IN	Nellie R Stevens Holly	<i>Ilex x 'Nellie R Stevens'</i>	15 gallon, 4'-5' ht.	41	Full to ground
CH	European Fan Palm	<i>Chamaerops humilis</i>	5 gallon, 18"-20" ht.	73	Full to ground
	Podocarpus	<i>Podocarpus macrophyllus</i>	7 gallon, 24"-30" ht.	174	Full to ground
	Liquidambar	<i>Liquidambar japonicum 'Recurvifolium'</i>	7 gallon, 24"-30" ht.	199	Full to ground
	Viburnum	<i>Viburnum suspensum</i>	7 gallon, 24"-30" ht.	31	Full to ground
	Wintergreen Boxwood	<i>Buxus microphylla 'Wintergreen'</i>	7 gallon, 18"-24" ht.	32	Full to ground
	Dwarf Palmetto	<i>Sabal minor</i>	5 gallon, 15"-18" ht.	113	
	Saw Palmetto	<i>Serenoa repens</i>	5 gallon, 15"-18" ht.	205	
	Spreading Sasanqua	<i>Camellia sasanqua 'Shi-Shi Gashira'</i>	5 gallon, 10"-12" ht.	76	
	Dwarf Yaupon Holly	<i>Ilex vomitoria 'Nana'</i>	7 gallon, 15"-18" ht.	343	
	Plum Yew	<i>Cephalotaxus harringtonia 'Prostrata'</i>	5 gallon, 8"-10" ht., 12"-15" spread	107	
	Soft Caress Mahonia	<i>Mahonia eurbracteata 'Soft Caress'</i>	5 gallon, 10"-12" ht., 12"-15" spread	8	
LL	Preeze Grass	<i>Lomandra longifolia</i>	5 gallon, 36" o.c., 12"-15" ht.	459	See plant key for hatch pattern
TA	Asiatic Jasmine	<i>Trachelospermum asiaticum</i>	4" pot, 18" o.c.	598	See plant key for hatch pattern
ANN	Annuals		flats	12	
	Creeping Fig	<i>Ficus pumila</i>	1 gallon	12	
	Bermuda Sod		SQFT	360,922	
	Hardwood Mulch		3" Depth, cubic yards	173	
	Pine Straw Mulch		3" Depth, Bales (1 bale per 45 sqft)	1,050	

GENERAL NOTES:

- DEAD OR DAMAGED LIMBS AND FRONDS ARE TO BE REMOVED FROM ALL EXISTING TREES THROUGHOUT THE SITE.
- EXISTING TREES TO BE LIMBED UP TO AN AVERAGE HEIGHT OF 20' WITH THE EXCEPTION OF MULTI-TRUNK OR NATURALLY TREES SUCH AS MYRTLE OR BRADFORD PEAR.
- NATURAL BUFFERS ARE TO BE CLEANED OF ALL VINES AND UNDESIRABLE GROWTH. THE GROUND UNDER THE BUFFERS WILL BE COVERED BY EITHER MULCH OR BERMUDA GRASS DEPENDING ON THE SHADE PROVIDED BY THE TREE CANOPY ABOVE.
- UNSATISFACTORY SITE CONDITIONS THAT ADVERSELY AFFECT THE ESTABLISHMENT OF HEALTHY PLANT MATERIAL MUST BE BROUGHT TO THE ATTENTION OF THE LANDSCAPE ARCHITECT PRIOR TO THE INSTALLATION OF ANY PLANT MATERIAL.
- ALL LANDSCAPE AREAS IN AND AROUND PARKING AND DRIVES ARE TO HAVE A 12" TO 18" CROWN FROM BACK OF CURB OR ROADWAY.
- ALL LANDSCAPE AREAS ARE TO BE TREATED WITH HERBICIDE AND PRE-EMERGENCE PRIOR TO PLANT MATERIAL INSTALLATION.
- ALL LANDSCAPE BEDS ARE TO RECEIVE HARDWOOD MULCH TO A UNIFORM DEPTH OF 3" & NATURAL AREAS TO RECEIVE PINE STRAW MULCH AT 4" DEPTH.
- ALL TREES IN GRASS AREAS WILL HAVE A MULCH RING WITH A MINIMUM RADIUS OF 24".
- THE CONTRACTOR WILL BE HELD RESPONSIBLE FOR VERIFYING THE QUANTITY OF PLANTS SHOWN ON THE PLANTING PLAN.
- ANY DEVIATIONS FROM THE PLANT MATERIALS LIST MUST BE APPROVED BY CITY OF MYRTLE BEACH.
- THE LANDSCAPE ARCHITECT RETAINS THE RIGHT TO REFUSE ALL PLANTS THAT DO NOT MEET MINIMUM SPECS. IN PLANT LIST.
- THE LANDSCAPE CONTRACTOR IS RESPONSIBLE FOR MAINTENANCE FOR 30 DAYS AFTER FINAL ACCEPTANCE.
- ALL PLANT MATERIAL WILL BE GUARANTEED FOR ONE CALENDAR YEAR FROM DATE OF FINAL ACCEPTANCE. PLANTS MUST BE IN SATISFACTORY CONDITION AT END OF GUARANTEED PERIOD.
- ALL PLANT MATERIAL SIZES TO MEET OR EXCEED AMERICAN STANDARDS FOR NURSERY STOCK.
- THE OWNER IS RESPONSIBLE FOR PROPER MAINTENANCE DURING THE GUARANTEE PERIOD. THE CONTRACTOR SHALL NOTIFY THE OWNER IN WRITING IF MAINTENANCE IS UNSATISFACTORY. CONTINUED IMPROPER MAINTENANCE OR ACTS OF GOD WILL VOID GUARANTEE. CONTRACTOR SHALL PROVIDE MAINTENANCE INSTRUCTIONS TO THE OWNER BEFORE FINAL PAYMENT IS MADE.
- EXISTING GRASSED AREAS ARE TO BE PRESERVED WHENEVER POSSIBLE AND HYDRO-SEEDED BEFORE JOB COMPLETION WHERE DAMAGED HAS OCCURRED.
- ALL PLANTINGS AND SOD TO BE COVERED BY AUTOMATIC IRRIGATION. LANDSCAPE CONTRACTOR TO PROVIDE AS-BUILT OF COMPLETED SYSTEM.
- THIS PLAN IS THE PROPERTY OF WACCAMAW LANDSCAPING AND CONSTRUCTION CO. INC., PAWLEYS ISLAND, S.C.
- ALL BASE INFO. WAS PROVIDED BY THOMAS & HUTTON ENGINEERING, MYRTLE BEACH, S.C. AND WACCAMAW LANDSCAPING AND CONSTR. CO. INC., PAWLEYS ISLAND, S.C. SHOULD IN NO WAY BE HELD RESPONSIBLE FOR THE ACCURACY OF CONTENTS OF THESE PLANS.
- TREES & SHRUBS TO BE FIELD ADJUSTED TO AVOID INTERFERENCE WITH LIGHTING.



ARCHITECTURE PLANNING

North Carolina  
3333 Jaeckle Drive, Suite 120  
Wilmington, NC 28403  
910.341.7600

Maryland  
312 West Main St., Suite 300  
Salisbury, MD 21801  
410.546.9100

Delaware  
309 S Governors Ave  
Dover, DE 19904  
302.734.7950

Rittenhouse Station  
250 South Main Street, Suite 109  
Newark, DE 19711  
302.369.3700  
www.beckermorgan.com



611 Burroughs & Chapin Blvd. • Suite 202  
Myrtle Beach, SC 29577 • 843.839.3545  
www.thomasandhutton.com

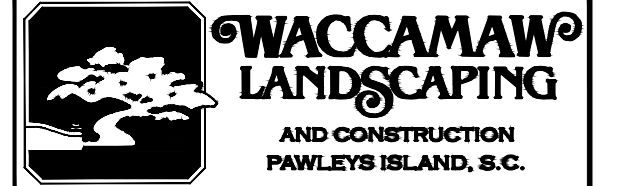

P.O. Box 213 • 1066 Petigru Dr.  
Pawleys Island, SC 29585 • 843-237-2224  
www.waccamawlandscaping.com

PROJECT TITLE  
HGTC - GRAND STRAND  
LANDSCAPING AND  
IRRIGATION

743 HEMLOCK AVENUE  
MYRTLE BEACH, SC 29577

S.C. OSC PROJECT NUMBER:  
H59-N035-MJ

SHEET TITLE  
PLANT SCHEDULE  
& PLANTING DETAILS

ISSUE BLOCK

#	Date	Description
1		
2		
3		
4		
5		
6		
7		
8		
9		
10		
11		
12		
13		
14		
15		
16		
17		
18		
19		
20		
21		
22		
23		
24		
25		
26		
27		
28		
29		
30		
31		
32		
33		
34		
35		
36		
37		
38		
39		
40		
41		
42		
43		
44		
45		
46		
47		
48		
49		
50		

PROJECT NO: J - 27742.0002  
DATE: 04/19/2021  
SCALE: 1" = 20'  
DRAWN BY: MGM PROJ MGR: JCR

L110  
COPYRIGHT © 2019



## GENERAL NOTES

1. ALL TRENCHING TO BE OUTSIDE OF TREE DRIP LINE
2. MAINLINE TO HAVE MINIMUM OF 18" OF COVER AND A MINIMUM OF 18" OFF OF THE HARDSCAPE
3. LATERALS TO HAVE MINIMUM OF 12" OF COVER AND A MINIMUM OF 12" OFF OF THE HARDSCAPE
4. NO ROCKS, BOULDERS OR SHARP OBJECTS TO BE IN TRENCH BACKFILL
5. ALL PIPE TO BE INSTALLED AS PER MANUFACTURERS SPECIFICATIONS
6. SPRINKLERS AND RELATED EQUIPMENT TO BE INSTALLED AS PER DETAILS
7. TWO WIRE CONTROL WIRE TO BE 14 GA UL 2 CONDUCTOR, JACKETED AND APPROVED BY 2-WIRE CONTROLLER MANUFACTURER
8. ALL 2-WIRE CONTROL WIRE TO HAVE 14GA "BLUE" TRACER WIRE FROM THE CONTROLLER TO ALL CONTROL VALVES. TRACER WIRE TO HAVE A 24" LOOP LOCATED IN EACH CONTROL VALVE AND ISOLATION VALVE BOXES.
9. WIRE SPLICES TO BE DONE AS PER DETAILS
10. ALL WIRE SPLICES OUTSIDE OF CONTROL VALVE BOX TO BE IN 10" VALVE BOX
11. TWO WIRE CONDUCTORS TO BE COLOR CODED
12. CONTRACTOR SHALL INSTALL MANUFACTURERS GROUNDING EQUIPMENT ON BOTH THE POWER AND OUTPUT SIDES OF CONTROLLER, ALL GROUNDING POINTS TO BE INSTALLED AS PER PLANS AND DETAILS
13. AT EACH VALVE AND CHANGE IN MAINLINE DIRECTION CONTRACTOR TO INSTALL A 30" LOOP OF EXTRA WIRE
14. SPRINKLERS ARE TO BE ADJUSTED TO AVOID OVER-SPRAY INTO NON-IRRIGATED AREAS
15. ELECTRIC CONTROL VALVES ARE TO BE INSTALLED IN VALVE BOXES AS FOLLOWS  
14" RECTANGULAR MINIMUM FOR EACH ELECTRIC CONTROL VALVE
16. SPRINKLERS TO BE INSTALLED 12" FROM FOUNDATIONS AND 2" FROM HARDSCAPE
17. CONTRACTOR TO ADD RISER EXTENSIONS TO SPRINKLERS IF REQUIRED TO MAINTAIN PROPER COVERAGE
18. ALL PIPING TO BE FLUSHED PRIOR TO INSTALLATION OF SPRINKLERS
19. ALL VALVES, QUICK COUPLER VALVES, WIRE SPLICES TO BE IN LANDSCAPED BEDS WHEREVER POSSIBLE
20. CONTRACTOR IS RESPONSIBLE FOR OBTAINING PROPER COVERAGE OF AREA TO BE IRRIGATED. MAKE ADJUSTMENTS AS NECESSARY
21. CONTRACTOR SHALL EXERCISE CARE NOT TO DAMAGE EXISTING UTILITIES REPAIRING ANY DAMAGES AT HIS OWN COST
22. PLAN IS DIAGRAMMATIC TO IMPROVE CLARITY ALL IRRIGATION EQUIPMENT TO BE INSTALLED WITHIN PROPERTY LINES AND LANDSCAPED AREAS
23. ANY DISCREPANCIES BETWEEN THE PLAN AND THE SITE TO BE REFERRED TO THE OWNERS REPRESENTATIVE PRIOR TO CONSTRUCTION
24. CONTRACTOR TO PROVIDE 1 YEAR WARRANTY OF ALL PRODUCTS AND WORKMANSHIP TO INCLUDE WINTERIZATION AND SPRING START-UP
25. CONTRACTOR TO PROVIDE OWNER AND OR LANDSCAPE ARCHITECT RECORD DRAWING PRIOR TO SUBSTANTIAL COMPLETION
26. INSTALLATION OF IRRIGATION SLEEVES IS THE IRRIGATION CONTRACTORS RESPONSIBILITY. IRRIGATION CONTRACTOR TO COORDINATE WITH GENERAL CONTRACTOR SLEEVE INSTALLATION PRIOR TO PAVEMENT INSTALLATION
27. CLEANUP AND DISPOSE OF ALL DEBRIS, WASTE AND EXCESS CONSTRUCTION MATERIALS LEAVE AREA NEAT, CLEAN AND READY FOR OWNERS USE PROVIDE CLEAN PAVEMENT SURFACES INCLUDING AREAS OF PUBLIC R.O.W.

## TWO WIRE CONTROL SYSTEM NOTES

1. ALL DECODER WIRE SPICE CONNECTORS TO BE 3M DBRY-6 OR BETTER.
2. ALL DECODER TO VALVE SOLENOID SPICE CONNECTORS TO BE 3M DBRY-6 OR BETTER
3. ALL GROUNDING POINTS TO HAVE BL-LA01 LIGHTNING ARRESTOR INSTALLED INLINE AS PER MANUFACTURER'S REQUIREMENTS AND INSTALLED AS PER DETAIL.
4. ALL BASELINE PRODUCTS TO BE INSTALLED AND OPERATED AS PER THE MANUFACTURER'S RECOMMENDATIONS AND OR REQUIREMENTS.
5. IRRIGATION CONTRACTOR IS RESPONSIBLE FOR OBTAINING ALL NECESSARY BASELINE INSTALLATION TRAINING PRIOR TO PROJECT START. NOTIFY IRRIGATION CONSULTANT WHEN TRAINING HAS BEEN COMPLETED.
6. IRRIGATION CONTRACTOR IS RESPONSIBLE FOR ALL REQUIREMENTS NECESSARY TO OBTAIN BASELINE EXTENDED 5 YEAR WARRANTEE. PROVIDE 5 YEAR WARRANTEE PRIOR TO SUBSTANTIAL COMPLETION
7. IRRIGATION CONTRACTOR IS RESPONSIBLE FOR TRAINING OWNERS STAFF, AS NEEDED, ON THE OPERATION AND MAINTENANCE OF BASELINE CONTROL SYSTEM.
8. IRRIGATION CONTRACTOR IS RESPONSIBLE FOR COMPLETE PROGRAMMING AND OPERATION OF BASELINE CONTROL SYSTEM FOR 6 MONTHS FROM THE DAY THE CONTROLLER BECOMES FUNCTIONAL. CONTRACTOR TO PROVIDE THE OWNERS REPRESENTATIVE A COMPUTER SPREAD SHEET THAT SHOWS EACH PROGRAM OPERATIONAL DAYS AND RUN TIMES PER ZONE.
9. CONTROLLER AND FLOW SENSOR ARE TO BE PROGRAMMED FOR FLOW MAXIMIZATION.

## IRRIGATION WELL NOTES

1. FOR BIDDING PURPOSES ASSUME A WELL DEPTH OF 550'. PROVIDE UNIT COST PER LF FOR WELL DEPTH LESS THAN OR GREATER THAN THE 550' BASE BID DEPTH.
2. FOR BIDDING PURPOSES ASSUME A PUMP SET DEPTH OF 100'. PROVIDE UNIT COST PER LF FOR PUMP DISCHARGE PIPE AND POWER WIRE LESS THAN OR GREATER THAN THE 100' BASE DEPTH.
3. INSTALL WELL SCREEN, OF SUFFICIENT SIZE AND TYPE TO ALLOW REQUIRED FLOW, TO ENSURE NO GRANULAR MATERIAL WILL BE PUMPED OUT OF THE WELL AT ANY TIME DURING IRRIGATION SYSTEM OPERATION.
4. DEVELOP WELL TO ENSURE ALL DEBRIS IN THE WELL FROM THE DRILLING PROCESS IS REMOVED.
5. WELL AND PUMP SYSTEM TO PROVIDE A MINIMUM OF 50 GPM AT A DISCHARGE PRESSURE OF 20 PSI AT THE TOP OF THE WELL HEAD.
6. PUMP TO BE INSTALLED ON GALVANIZED STEEL OR CERTA-LOC DROP PIPE WITH BRONZE CHECK VALVE ABOVE THE PUMP END.
7. FINISH WELL ABOVE GRADE AS PER CODE. PROVIDE 2" GALVANIZED PIPE FROM TEE ON TOP OF WELL HEAD TO A POINT 18" BELOW FINISHED GRADE AND FINISH WITH ELBOW AND PLUG.
8. WELL TO BE TEST PUMPED AT 50 GPM FOR A MINIMUM OF 8 HOURS TO INSURE CONSISTENT SUPPLY OF WATER TO THE IRRIGATION SYSTEM. ALL WATER PUMPED DURING TEST TO BE PIPED DIRECTLY TO STORM DRAIN.
9. PROVIDE WRITTEN REPORT OF WELL TEST TO THE OWNERS REPRESENTATIVE, LANDSCAPE ARCHITECT AND IRRIGATION CONSULTANT. REPORT TO INCLUDE DATE OF TEST, START AND STOP TIMES OF TEST, FLOW RATE MEASUREMENT METHOD, WATER LEVEL IN WELL AT THE TEST START AND TEST FINISH.
11. PROVIDE ALL NECESSARY ELECTRICAL EQUIPMENT BETWEEN THE PUMP CONTROL SYSTEM AND THE WELL PUMP MOTOR TO INSURE PUMP OPERATES PROPERLY.
12. POWER, 208 3P, FOR THE PUMP WILL BE PROVIDED TO THE WELL LOCATION.
13. WELL DRILLER IS RESPONSIBLE FOR ALL PERMITS, TESTS AND FEES REQUIRED TO CONSTRUCT THE WELL SYSTEM. COPIES OF ALL PERMITS TO BE PROVIDED TO OWNER WITHIN 7 DAYS OF RECEIPT.
14. PROVIDE DETAILED LISTING AND SUBMITTAL DRAWINGS OF ALL COMPONENTS TO BE USED TO CONSTRUCT THE WELL AND INSTALL THE PUMP FOR APPROVAL BY OWNER REPRESENTATIVES, PRIOR TO START OF WELL CONSTRUCTION.
15. ALL WORK TO BE IN ACCORDING TO THE WATER WELL STANDARDS ACT OF 1985, O.C.G.A. 125-120 (2011).
16. ALL POWER WIRE FROM THE VFD TO THE WELL HEAD TO BE IN SCH 40 PVC ELECTRICAL CONDUIT.

## VALVE SCHEDULE

NUMBER	MODEL	SIZE	TYPE	GPM	PSI	PSI @ POC	PRECIP
C1	Hunter ICV-G-FS	1-1/2"	Turf Spray	39.71	32.67	41.25	1.75 in/h
C2	Hunter ICV-G-FS	1-1/2"	Turf Spray	43.88	33.31	41.86	1.87 in/h
C3	Hunter ICZ-101-25	1"	Area for Dripline	5.30	25.39	33.93	0.64 in/h
C4	Hunter ICV-G-FS	1-1/2"	Turf Spray	33.93	33.48	40.74	1.98 in/h
C5	Hunter ICZ-101-25	1"	Area for Dripline	7.94	29.92	36.16	0.64 in/h
C6	Hunter ICZ-101-25	1"	Area for Dripline	7.58	27.58	35.23	0.64 in/h
C7	Hunter ICV-G-FS	1-1/2"	Turf Spray	32.38	33.40	40.67	2.04 in/h
C8	Hunter ICV-G-FS	1-1/2"	Turf Rotor	26.20	38.16	45.83	0.49 in/h
C9	Hunter ICV-G-FS	1-1/2"	Turf Rotor	43.90	40.04	46.70	0.53 in/h
C10	Hunter ICV-G-FS	1-1/2"	Turf Rotor	47.80	39.58	44.59	0.51 in/h
C11	Hunter ICZ-101-25	1"	Area for Dripline	3.24	25.07	28.32	0.64 in/h
C12	Hunter ICV-G-FS	1"	Turf Rotary	14.00	43.33	49.03	0.42 in/h
C13	Hunter ICV-G-FS	1"	Shrub Spray	1.30	32.05	39.23	1.51 in/h
C14	Hunter ICZ-101-25	1"	Area for Dripline	13.05	35.45	43.25	0.64 in/h
C15	Hunter ICV-G-FS	1"	Turf Spray	23.50	35.53	43.60	1.48 in/h
C16	Hunter ICV-G-FS	1-1/2"	Turf Rotary	52.42	44.65	52.68	0.40 in/h
C17	Hunter ICV-G-FS	1"	Turf Rotary	22.68	48.98	55.78	0.57 in/h
C18	Hunter ICV-G-FS	1-1/2"	Turf Rotary	37.05	43.48	49.71	0.36 in/h
C19	Hunter ICV-G-FS	1"	Bubbler	16.00	34.74	41.31	30.64 in/h
C20	Hunter ICZ-101-25	1"	Area for Dripline	5.40	25.61	32.20	0.64 in/h
C21	Hunter ICV-G-FS	1-1/2"	Turf Rotary	48.48	47.28	54.15	0.43 in/h
C22	Hunter ICV-G-FS	1-1/2"	Turf Rotary	53.93	45.59	50.87	0.38 in/h
C23	Hunter ICV-G-FS	1-1/2"	Turf Rotary	61.40	48.06	52.55	0.32 in/h
C24	Hunter ICV-G-FS	1-1/2"	Turf Rotary	56.15	44.06	47.72	0.48 in/h
C25	Hunter ICZ-101-25	1"	Area for Dripline	11.25	32.96	36.55	0.64 in/h
C26	Hunter ICV-G-FS	1"	Turf Spray	20.93	34.08	35.22	1.55 in/h
C27	Hunter ICV-G-FS	1-1/2"	Turf Rotary	29.54	39.54	41.99	0.41 in/h
C28	Hunter ICV-G-FS	1-1/2"	Turf Rotor	35.00	38.20	45.13	0.38 in/h
C29	Hunter ICV-G-FS	1"	Turf Rotary	18.47	44.55	49.85	0.44 in/h
C30	Hunter ICV-G-FS	1-1/2"	Turf Rotor	38.50	38.88	44.08	0.49 in/h
C31	Hunter ICV-G-FS	1-1/2"	Turf Rotary	51.86	45.04	50.53	0.38 in/h
C32	Hunter ICZ-101-25	1"	Area for Dripline	12.12	25.06	31.58	0.64 in/h
C33	Hunter ICV-G-FS	1-1/2"	Turf Rotary	43.38	43.25	50.07	0.44 in/h
C34	Hunter ICZ-101-25	1"	Area for Dripline	8.22	28.93	35.77	0.64 in/h
C35	Hunter ICV-G-FS	1"	Turf Spray	18.20	34.35	41.62	1.69 in/h
C36	Hunter ICV-G-FS	1"	Turf Spray	19.23	34.21	41.50	1.29 in/h
C37	Hunter ICV-G-FS	1-1/2"	Turf Rotary	30.62	42.53	49.84	0.46 in/h
C38	Hunter ICZ-101-25	1"	Area for Dripline	12.12	33.75	41.45	0.64 in/h
C39	Hunter ICV-G-FS	1-1/2"	Turf Rotor	50.80	38.71	47.23	0.56 in/h
C40	Hunter ICZ-101-25	1"	Area for Dripline	3.92	25.42	34.38	0.64 in/h
C41	Hunter ICV-G-FS	1"	Turf Spray	13.00	37.15	46.15	1.89 in/h
C42	Hunter ICV-G-FS	1-1/2"	Turf Rotary	50.46	44.20	53.24	0.41 in/h
C43	Hunter ICV-G-FS	1-1/2"	Turf Rotary	49.58	44.47	54.04	0.42 in/h
C44	Hunter ICV-G-FS	1-1/2"	Turf Rotary	46.77	45.14	54.66	0.37 in/h
C45	Hunter ICV-G-FS	1-1/2"	Turf Spray	30.49	33.42	42.91	1.59 in/h
C46	Hunter ICV-G-FS	1"	Turf Rotary	16.71	43.53	51.76	0.41 in/h
C47	Hunter ICZ-101-25	1"	Area for Dripline	14.01	37.29	45.55	0.64 in/h
C48	Hunter ICV-G-FS	1-1/2"	Turf Rotary	43.48	45.07	52.34	0.45 in/h
C49	Hunter ICV-G-FS	1-1/2"	Turf Rotary	29.94	44.03	51.27	0.44 in/h
C50	Hunter ICZ-101-25	1"	Area for Dripline	7.49	28.15	35.36	0.65 in/h
C51	Hunter ICZ-101-25	1"	Area for Dripline	10.19	31.01	38.19	0.64 in/h
C52	Hunter ICV-G-FS	1-1/2"	Turf Rotor	40.20	38.46	46.83	0.45 in/h
C53	Hunter ICZ-101-25	1"	Area for Dripline	14.08	37.70	46.14	0.65 in/h
C54	Hunter ICV-G-FS	1"	Turf Rotary	22.35	45.59	55.95	0.45 in/h
C55	Hunter ICV-G-FS	1-1/2"	Turf Rotor	52.50	40.07	51.06	0.42 in/h
C56	Hunter ICV-G-FS	1-1/2"	Turf Rotor	66.40	40.06	51.10	0.44 in/h
C57	Hunter ICV-G-FS	1-1/2"	Turf Spray	27.89	33.73	45.28	1.68 in/h
C58	Hunter ICV-G-FS	1-1/2"	Turf Rotary	40.93	37.98	50.16	0.45 in/h
C59	Hunter ICV-G-FS	1"	Turf Rotary	22.55	46.41	59.02	0.52 in/h
C60	Hunter ICZ-101-25	1"	Area for Dripline	15.53	41.78	54.40	0.64 in/h
C61	Hunter ICV-G-FS	1-1/2"	Turf Rotor	36.70	37.97	50.61	0.45 in/h
C62	Hunter ICV-G-FS	1-1/2"	Turf Spray	24.19	36.08	49.40	1.61 in/h
C63	Hunter ICV-G-FS	1-1/2"	Turf Rotary	22.73	43.25	55.16	0.21 in/h
C64	Hunter ICZ-101-25	1"	Area for Dripline	11.49	35.17	47.32	0.64 in/h
C65	Hunter ICV-G-FS	1-1/2"	Turf Spray	32.86	35.10	47.28	1.56 in/h
C66	Hunter ICV-G-FS	1-1/2"	Turf Rotary	42.14	44.61	56.83	0.37 in/h
C67	Hunter ICZ-101-25	1"	Area for Dripline	13.89	38.43	50.21	0.64 in/h
C68	Hunter ICV-G-FS	1-1/2"	Turf Rotary	48.47	44.32	46.07	0.39 in/h
C69	Hunter ICV-G-FS	1-1/2"	Turf Spray	13.69	34.66	46.94	1.22 in/h
C70	Hunter ICV-G-FS	1-1/2"	Turf Rotary	48.33	46.03	58.34	0.47 in/h
C71	Hunter ICV-G-FS	1-1/2"	Turf Spray	45.06	36.29	49.43	1.80 in/h
C72	Hunter ICV-G-FS	1-1/2"	Turf Rotary	25.52	43.38	53.31	0.25 in/h
C73	Hunter ICZ-101-25	1"	Area for Dripline	6.57	26.73	35.80	0.64 in/h
C74	Hunter ICV-G-FS	1"	Turf Rotary	21.31	44.91	54.41	0.21 in/h
C75	Hunter ICZ-101-25	1"	Area for Dripline	11.85	33.63	43.60	0.64 in/h
C76	Hunter ICV-G-FS	1-1/2"	Turf Rotor	26.50	38.74	48.73	0.49 in/h
C77	Hunter ICV-G-FS	1"	Turf Rotor	15.70	40.79	50.78	0.46 in/h
C78	Hunter ICV-G-FS	1-1/2"	Turf Rotor	42.90	63.84	73.77	0.82 in/h
C79	Hunter ICV-G-FS	1-1/2"	Turf Rotor	57.20	65.80	75.71	0.42 in/h
C80	Hunter ICV-G-FS	1-1/2"	Turf Rotor	42.90	66.29	75.78	0.42 in/h
C81	Hunter ICV-G-FS	1-1/2"	Turf Rotor	52.10	67.75	77.23	0.45 in/h
C82	Hunter ICV-G-FS	1-1/2"	Turf Rotor	57.20	67.13	76.59	0.42 in/h
C83	Hunter ICV-G-FS	1-1/2"	Turf Rotor	57.20	66.82	76.55	0.42 in/h
C84	Hunter ICV-G-FS	1-1/2"	Turf Rotor	42.90	63.97	73.73	0.82 in/h
C85	Hunter ICV-G-FS	1-1/2"	Turf Rotor	57.20	66.11	78	0.41 in/h
C86	Hunter ICV-G-FS	1-1/2"	Turf Rotary	27.85	43.32	52.15	0.37 in/h
C87	Hunter ICZ-101-25	1"	Area for Dripline	11.88	34.14	43.02	0.64 in/h
C88	Hunter ICZ-101-25	1"	Area for Dripline	11.00	35.10	44.05	0.64 in/h

## DRIP ZONE NOTES

1. IT IS IRRIGATION CONTRACTOR'S RESPONSIBILITY TO ENSURE THAT EACH PLANT IS WITHIN THE DRIPLINE WETTED PATTERN ON NO LESS THAN 2 SIDES.
2. DRIPLINE TO BE LAID OUT AND INSTALLED AS DETAIL EXAMPLES.
3. DRIPLINE TO BE INSTALLED IN GRID FASHION WITH TUBING ON 18" CENTERS, ELBOWS AND TEES ARE TO BE USED FOR CHANGES IN DIRECTION, LOOPING OF DRIPLINE IS NOT ACCEPTABLE.
4. DRIPLINE IS TO BE INSTALLED, TESTED AND INSPECTED TO ENSURE EACH EMITTER FUNCTIONS PROPERLY PRIOR TO COVERING WITH MULCH.
5. ALL DRIPLINE SUPPLY PIPING TO BE CL 200 PVC.
6. ALL PIPING WITHIN A DRIP ZONE THAT IS UNDER THE HARDSCAPE TO BE CL 200 PVC.
7. DRIPLINE TO BE STAKED DOWN EVERY 3' AND WITHIN 1' OF ALL FITTING OUTLETS.
8. ALL FLUSH VALVES ARE TO BE INSPECTED FOR PROPER OPERATION.
9. IRRIGATION CONTRACTOR TO MEET WITH DRIP COMPONENT MANUFACTURERS REPRESENTATIVE AND OWNER'S REPRESENTATIVE ON SITE PRIOR TO CONSTRUCTION TO REVIEW DRIP COMPONENT CONSTRUCTION, OPERATION AND MAINTENANCE.

## BASEMANAGER REMOTE ACCESS NOTES

1. PROVIDE 5 YEAR SUBSCRIPTION, FOR THE OWNER, TO THE BASELINE BASEMANAGER REMOTE ACCESS CLOUD BASED SYSTEM.
2. FULLY SET UP BASEMANAGER TO ACCESS THE CONTROLLER AND ALLOW FOR ALL CONTROL SYSTEM ALERTS, CONTROLLER PROGRAMING, FLOW MAGNAMENT, MOISTURE SENSOR SET UP, AND PROGRAM SET UP.
3. DEVELOP THE MAPPING PORTION OF THE CONTROL SYSTEM TO SHOW A SITE MAP WITH ALL CONTROL VALVE, WATER METER, MOISTURE SENSOR LOCATIONS GEO-LOCATED ON THE MAP.
4. PROVIDE A MINIMUM OF 4 HOURS OF BASELINE REPRESENTATIVE TRAINING FOR THE OWNERS REPRESENTATIVES.

## IRRIGATION SCHEDULE

SYMBOL	MANUFACTURER/MODEL/DESCRIPTION
	Hunter ICV-G-FS 1" 1-1/2", 2", and 3" Plastic Electric Remote Control Valves, Globe Configuration, with NPT Threaded Inlet/Outlet, for Commercial/Municipal Use, With Filter Sentry.
	Hunter HQ-44LRC-AW Quick coupler valve, yellow rubber locking cover, red brass and stainless steel, with 1" NPT inlet, 2-piece body. Acme Key with Anti-Rotation Wings.
	Matco-Norca 10RT 2" to 6" cast iron gate isolation valve. Ring-Tite Gasket Ends. Resilient wedge with epoxy coating and optional nut. For IPS pipe. Same size as mainline pipe.
	Nibco T-113 Class 125 bronze gate shut off valve with wheel handle. same size as mainline pipe diameter at valve location. Size Range - 1/4" - 3"
	Baseline BL-3200X Two-wire controller in large 16-gauge powder-coated wall mount cabinet, expandable to 200 stations.
	2-Wire Grounding Point Install as per plan detail.
	2-Wire Grounding Point Install as per plan detail.
	Aerator Controller
	Pond Aerator, Pond 3 Kasco 3400JHF with stainless steel 3 light LED lighting kit.
	Pond Aerator, Ponds 1 and 2. Kasco 8400JF with stainless steel 3 light LED lighting kit.
	Pond Aerator, Ponds 1 and 2. Kasco 8400JF with stainless steel 3 light LED lighting kit.
	Watertronics Pump Station Model #wmlv-7000-1-20-460-3-2
	Irrigation Lateral Line: PVC Class 200 SDR 21
	Irrigation Mainline: PVC Class 200 SDR 21
	Pipe Sleeve: PVC Schedule 40
	Valve Cabinet
	Valve Number
	Valve Flow
	Valve Size

## REFERENCE NOTES SCHEDULE

SYMBOL	DESCRIPTION
	Irrigation system water source to be a pump station. System requirements are 200 gpm at a discharge pressure of 80 psi.
	Pump station filtration discharge pipe. Finish discharge pipe 24" below normal water level.
	Coordinate the exact location of the controller with the owners representative. Provide 120v 20 amp power to the controller from a dedicated circuit. Install incoming power surge protection as per manufacturers recommendations.
	Install 16ga shielded cable in 1" SCH 40 electrical conduit from the controller to the pump station. Connect wire to terminal block for flow data. Program controller to monitor flow and shut down any over flow zone(s).
	Pond recharge well. Well to provide a minimum of 50 gpm with a discharge pressure of 20 psi. Provide and install a level sensor (on off float) in the pond. Adjust float to ensure pond level is maintained as per owners requirements.
	Discharge pipe from the recharge well to the pond. Install with a minimum of 18" of cover. Terminate pipe 24" below normal water level.
	Owner to provide data cable to controller. Provide 5 year subscription to Baseline BaseManager in the owners name.
	Pipe location is diagrammatic. Install all pipe and control wire as per plan notes and details.
	Lateral supply header to the inline drip tubing grid. Typical for all lateral to dripline connections. See drip layout example details for further layout requirements.
	All mainline pipe 3" and larger to be gasket joint pipe. All fittings for the gasket joint pipe to be 200 psi PVC gasket joint, thrust blocked as per fitting manufacturer instructions and plan details.
	Aerator controller. Coordinate the exact location with the owners representative. Power will be provided to the location. Install as per manufacturers installation instructions.
	Pond Aerator, see Irrigation Schedule. Install as per manufacturers details and instructions.

## CRITICAL ANALYSIS

Generated: 2021-01-27 14:12

P.O.C. NUMBER: 01  
Water Source Information:





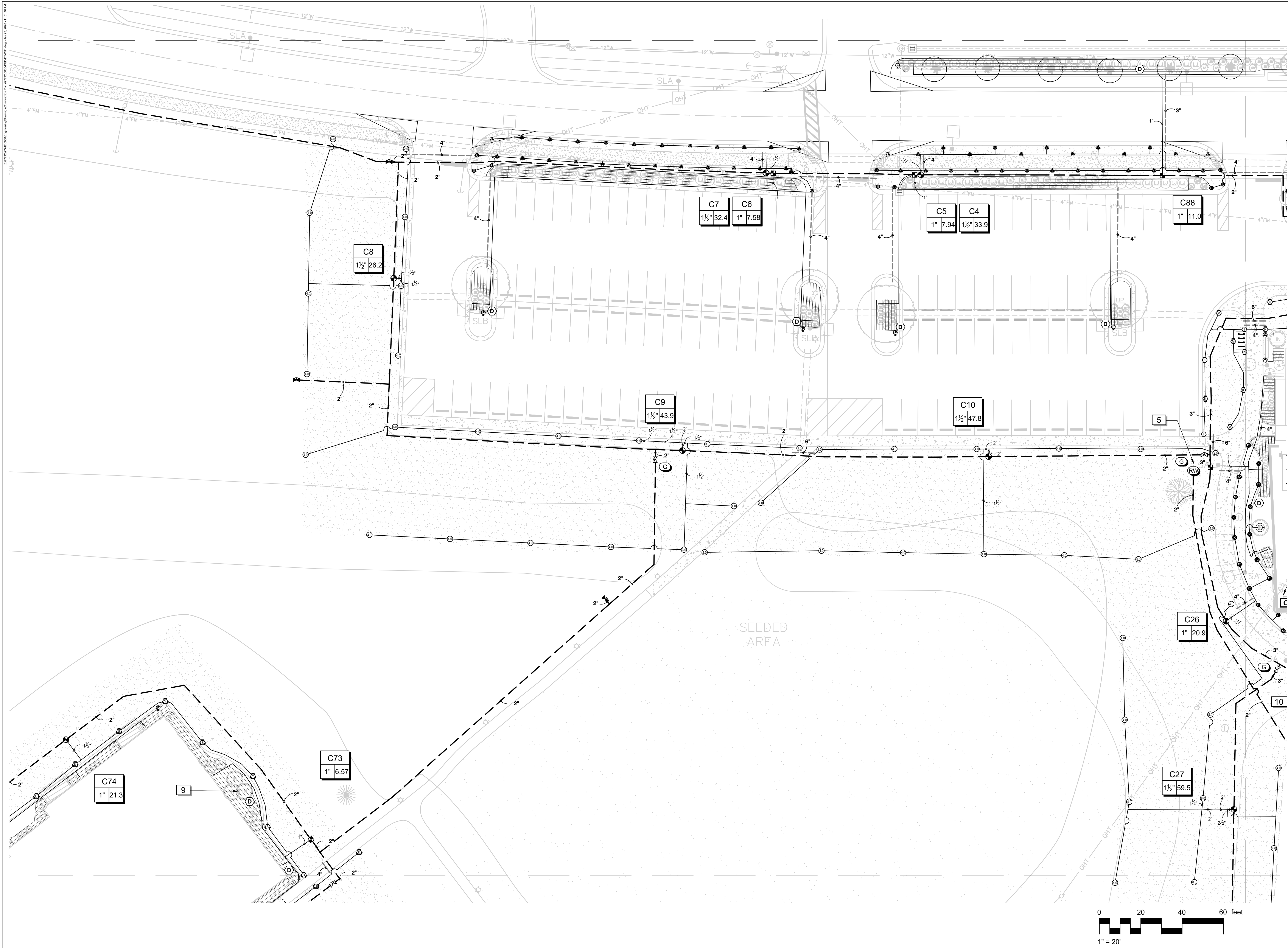

ARCHITECTURE  
PLANNING

North Carolina  
3333 Jaeckle Drive, Suite 120  
Wilmington, NC 28403  
910.341.7600

Maryland  
312 West Main St, Suite 300  
Salisbury, MD 21801  
410.546.9100

Delaware  
309 S Governors Ave  
Dover, DE 19904  
302.734.7950

Rittenhouse Station  
250 South Main Street, Suite 109  
Newark, DE 19711  
302.369.3700  
www.beckermorgan.com

THOMAS & HUTTON

611 Burroughs & Chapin Blvd. • Suite 202  
Myrtle Beach, SC 29577 • 843.839.3545  
www.thomasandhutton.com



PROJECT TITLE  
HGTC - GRAND STRAND  
LANDSCAPING AND  
IRRIGATION

743 HEMLOCK AVENUE  
MYRTLE BEACH, SC 29577  
S.C. OSE PROJECT NUMBER:  
H59-NO35-MJ

SHEET TITLE  
IRRIGATION PLAN

Mark	Date	Description
	04/19/2021	ISSUED FOR BID
PROJECT NO: J - 27742.0002		
DATE: 04/19/2021		
SCALE: N/A		
DRAWN BY: MDC PROJ MGR: WAW		

IR103  
COPYRIGHT © 2019

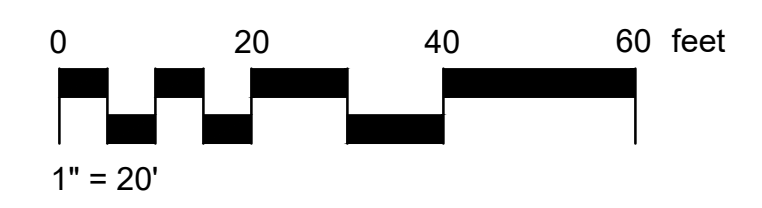



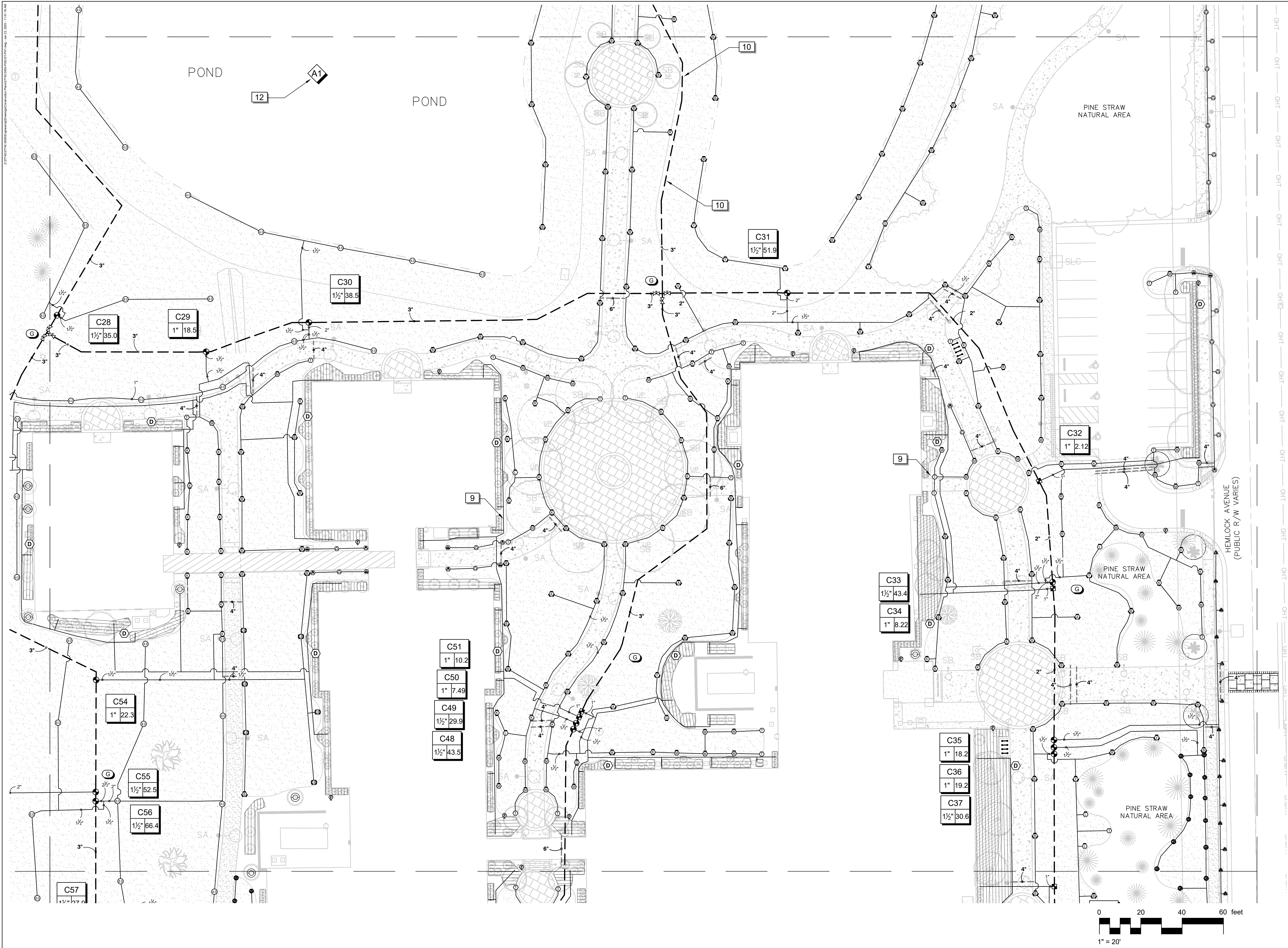

**BECKER MORGAN GROUP**  
 ARCHITECTURE PLANNING  
 North Carolina  
 3333 Jaeckle Drive, Suite 120  
 Wilmington, NC 28403  
 910.341.7600  
 Maryland  
 312 West Main St, Suite 300  
 Salisbury, MD 21801  
 410.546.9100  
 Delaware  
 309 S Governors Ave  
 Dover, DE 19904  
 302.734.7950  
 Rittenhouse Station  
 250 South Main Street, Suite 109  
 Newark, DE 19711  
 302.369.3700  
 www.beckermorgan.com

**THOMAS & HUTTON**  
 611 Burroughs & Chapin Blvd. • Suite 202  
 Myrtle Beach, SC 29577 • 843.839.3545  
 www.thomasandhutton.com



PROJECT TITLE  
**HGTC - GRAND STRAND LANDSCAPING AND IRRIGATION**

743 HEMLOCK AVENUE  
 MYRTLE BEACH, SC 29577  
 S.C. OSE PROJECT NUMBER:  
 H59-NO35-MJ

SHEET TITLE  
**IRRIGATION PLAN**

Mark	Date	Description
04/19/2021	ISSUED FOR BID	
<b>PROJECT NO: J - 27742.0002</b>		
<b>DATE: 04/19/2021</b>		
<b>SCALE: N/A</b>		
<b>DRAWN BY: MDC PROJ MGR: WAW</b>		

**IR105**  
 COPYRIGHT © 2019

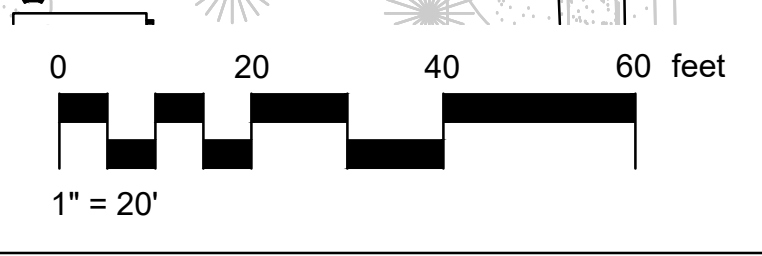



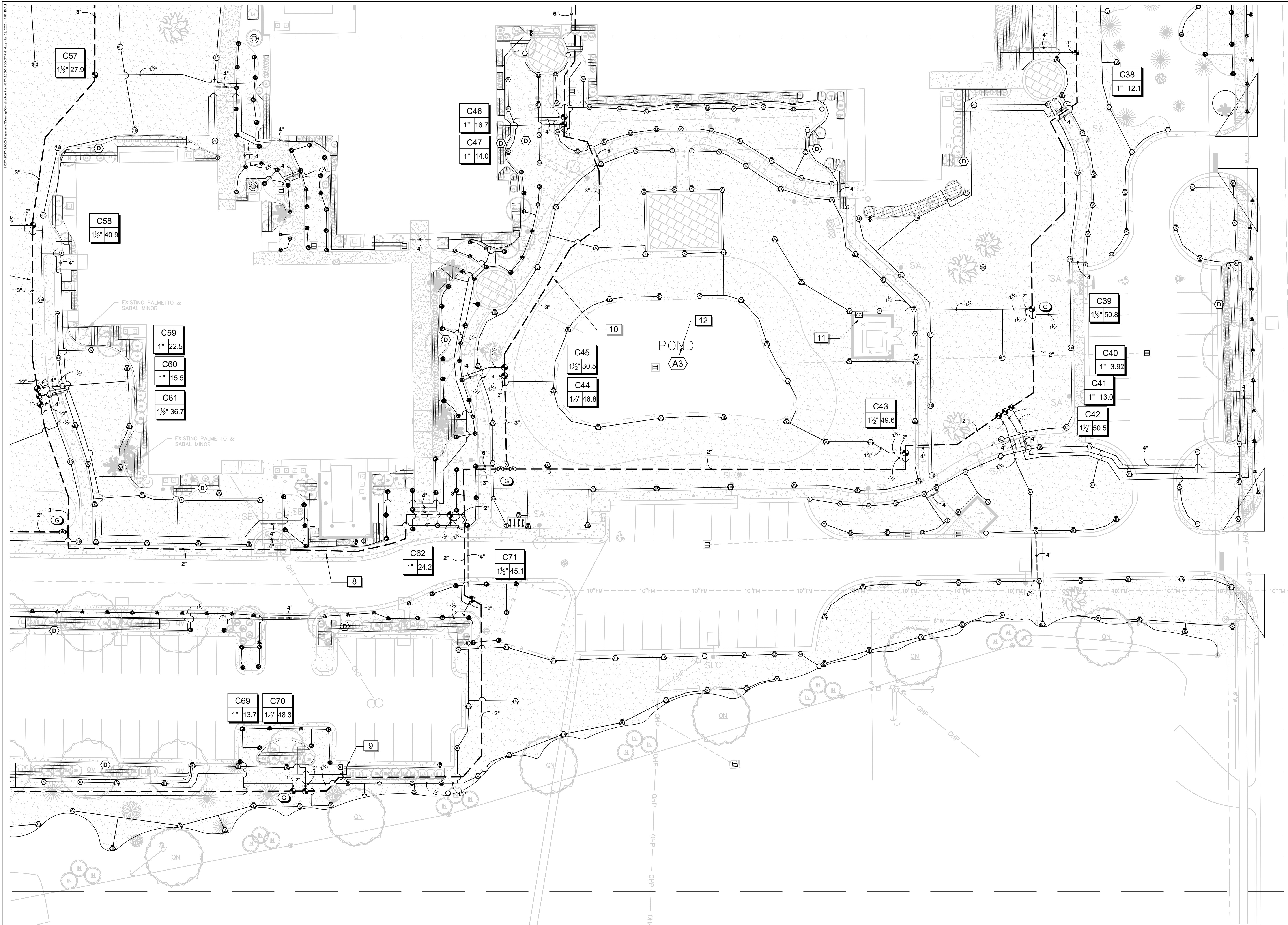

PROJECT TITLE  
**HGTC - GRAND STRAND  
LANDSCAPING AND  
IRRIGATION**

743 HEMLOCK AVENUE  
MYRTLE BEACH, SC 29577  
S.C. OSE PROJECT NUMBER:  
H59-NO35-MJ

SHEET TITLE  
**IRRIGATION PLAN**

Mark	Date	Description
	04/19/2021	ISSUED FOR BID

**PROJECT NO: J - 27742.0002**

**DATE: 04/19/2021**

**SCALE: N/A**

**DRAWN BY: MDC PROJ MGR: WAW**

**IR107**

COPYRIGHT © 2019

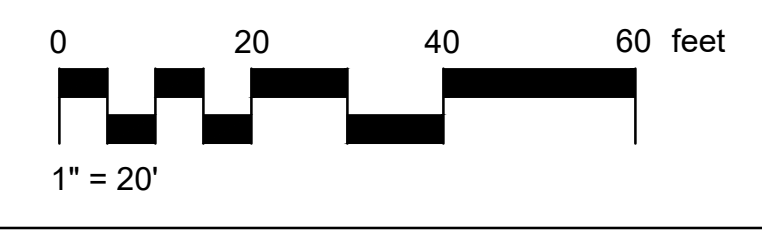













PROJECT TITLE  
**HGTC - GRAND STRAND  
LANDSCAPING AND  
IRRIGATION**

743 HEMLOCK AVENUE  
MYRTLE BEACH, SC 29577  
S.C. OSE PROJECT NUMBER:  
H59-NO35-MJ

SHEET TITLE  
**IRRIGATION PUMP  
STATION DETAILS**

Mark	Date	Description
	04/19/2021	ISSUED FOR BID

PROJECT NO: **J - 27742.0002**

DATE: **04/19/2021**

SCALE: N/A

DRAWN BY: MDC PROJ MGR: WAW

**IR112**

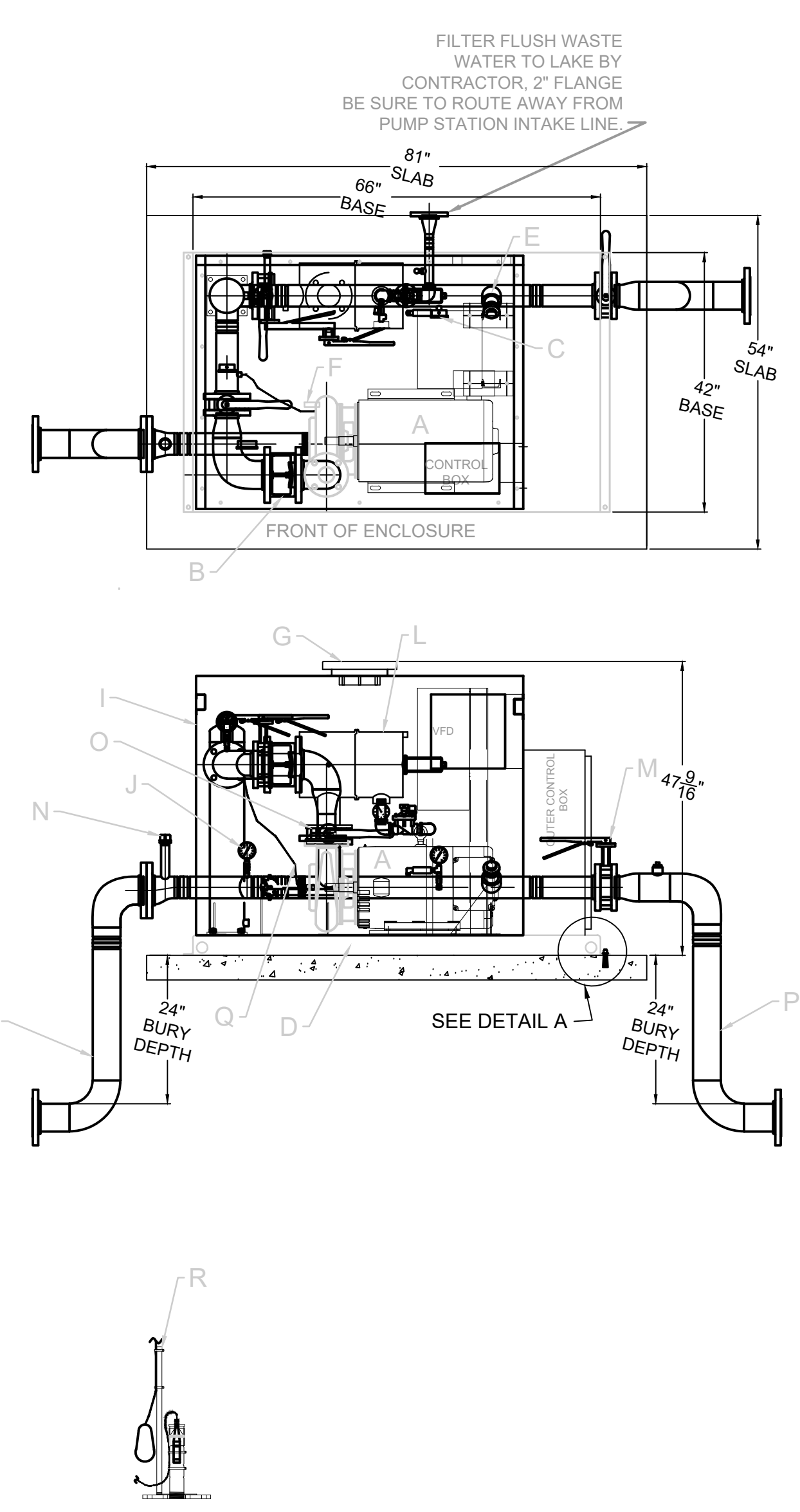
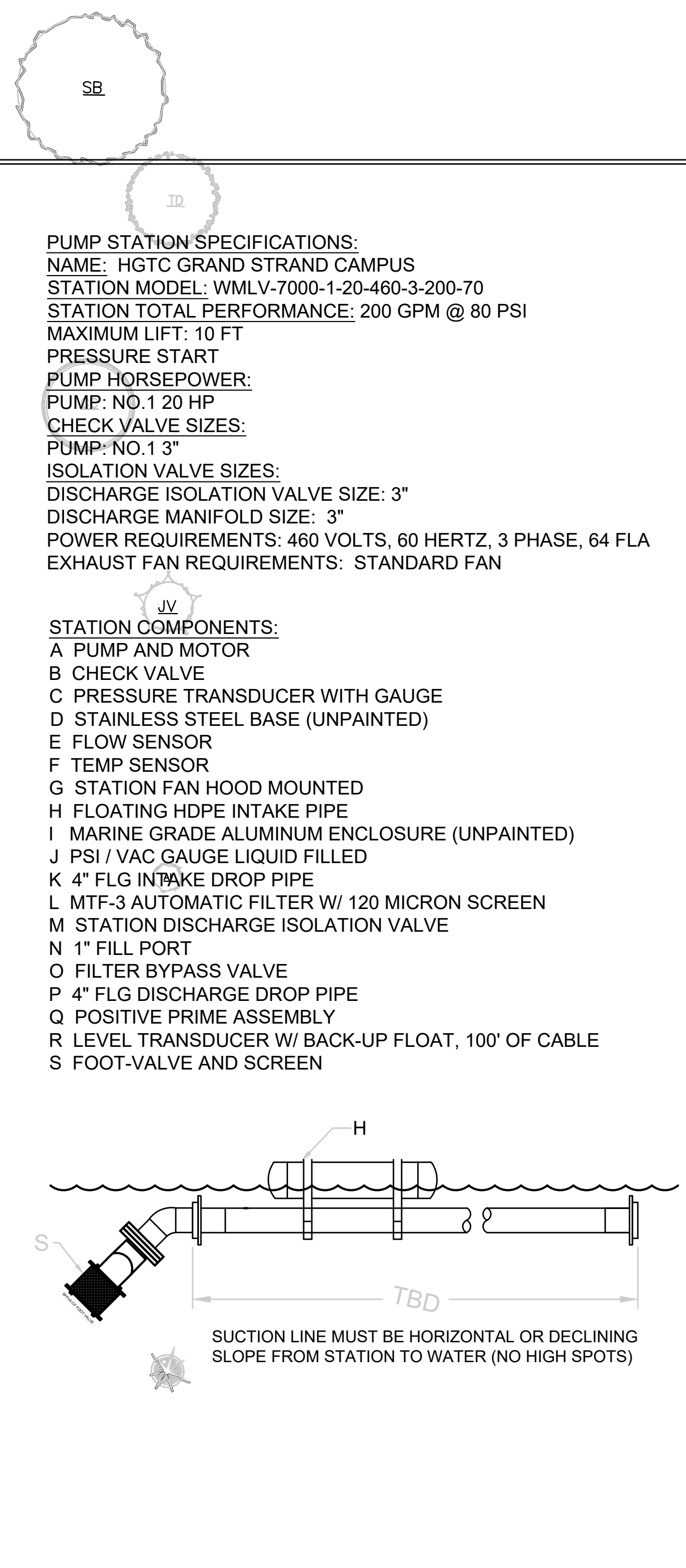

NO.	DATE	BY	DESCRIPTION	CHK	DATE	CHK BY
7						
6						
5						
4						
3						
2						
1						

DRAWN BY: PJB	DATE: 10/27/2020	TITLE:
CHECKED BY: ---	DATE:	HGTC GRAND STRAND CAMPUS IRRIGATION PUMP STATION
THIS DRAWING AND DESIGN IS THE PROPERTY OF WATERTRONICS AND IS NOT TO BE REPRODUCED IN WHOLE OR PART, NOR EMPLOYED FOR ANY PURPOSE OTHER THAN SPECIFICALLY PERMITTED IN WRITING BY WATERTRONICS. THIS DRAWING LOANED AND SUBJECT TO RETURN ON DEMAND		<b>WATERTRONICS</b>
SCALE: NTS	SHEET 1 OF 1 SHEETS	
JOB NO.: ---	DRAWING NO. PRST14255	

**25** PUMP STATION

NOTE:  
 PUMP STATION SHOWN IS THE BASIS FOR DESIGN. OTHER ACCEPTABLE PUMP STATION MANUFACTURERS ARE MUNRO PUMPING SYSTEMS, GRAND JUNCTION CO AND TPS, LIBERTY SC. ALTERNATIVE PUMPING SYSTEM TO BE PRE- APPROVED PRIOR TO BIDDING, SEE SPECIFICATIONS.

2:27:07 PM 05/20/2023 11:15:10 AM

MODEL WM7000 PUMP STATION GENERAL SPECIFICATIONS

Project Name: HGTC Grand Strand Campus
Project Location: 600 WMLV-7000-1-20-230-3-200-80
Pumping System Model #: WMLV-7000-1-20-230-3-200-80
Station Design Capacity: 200 GPM @ 80 PSI Discharge

SCOPE OF WORK

It is the intention of this specification to describe a self enclosed automatic pump station for a turf irrigation system. This is to be accomplished by using a completely prefabricated pump station conforming to the following specifications.

The pumping station shall be WaterMax Model # WM7000 as manufactured by WATERTRONICS, INC. 525 Industrial Drive, P.O. Box 530, Hartland, Wisconsin 53029-0530, www.watertronics.com.

MANUFACTURER REQUIREMENTS

The pump station shall be manufactured by Watertronics, Inc., Hartland, Wisconsin. The following information must be furnished by the contractor or manufacturer's representative within 10 days before bid date, to the Consultant/Engineer for consideration as an equal brand.

- a. A complete specification and submittal of all major components for the proposed pump station with individual pump performance verification.
b. A detailed pumping station proposal drawing complete with component location, sizes and dimensions specific to the installation.
c. A complete electrical schematic for all high and low voltage circuits showing breaker/ fuse sizing, wire numbering and color.
d. Pump station manufacturers U.L. file number for the electrical controls and pump station.
e. A copy of the manufacturer's certificate of insurance.
f. Product support technicians shall be capable of accessing all information pertaining to the pumping equipment, e.g. electrical schematics, pump curves, program data, bill of materials, etc. The manufacturer shall have no less than two technicians on call seven days a week.
g. The pump station manufacturer shall provide factory authorized or factory direct service personnel for the set, start-up, preventative maintenance and general service of the pump system. A factory authorized or factory direct service technician must be located within one-hundred (100) mile radius of the project site. The pump systems technician must have a minimum of 5 years experience. The pump station manufacturer shall provide technical phone support twenty-four hours a day seven days a week.

SECTION 1: GENERAL

1.1 The pump station performance at enclosure limits shall be as noted in the technical specifications. The capacity, discharge pressure, dynamic inlet pressure and intake and discharge pipe dimensions shall be per

the technical specifications. The pump shall operate at no more than 3600 RPM. The power supply to the station shall be as noted in the technical specifications.

1.2 The station shall be completely wired, piped, dynamically flow and pressure tested prior to shipment.

1.3 Operational sequence: The pump shall activate automatically upon a drop in pressure. Operation shall be maintained at an adjustable minimum flow. The pump shall be automatically retired when system flow drops below the minimum adjustable set point for an adjustable time delay.

1.4 Construction: Construction shall be of modular form utilizing a steel base structurally adequate to support pumps, piping, and electrical equipment as a single integral assembly. All nuts, bolts washers, and fasteners shall be stainless steel, zinc or cadmium plated for corrosion resistance.

SECTION 2: PUMP AND MOTOR

2.1 PUMP

Pump shall be electric motor driven, horizontal centrifugal with mechanical shaft seal, volute case and impeller. The shaft seal shall be a self-adjusting mechanical type to prevent leakage and eliminate the need for drain piping. The volute case shall be precision machined from gray cast iron and engineered to modern hydraulic standards. It shall be possible to rotate the discharge connection to any of four positions. A heavy cast iron bracket shall maintain alignment between the motor and volute case. The impeller shall be an enclosed type and balanced to provide smooth operation. The impeller shall be keyed to the shaft and locked with a special cap screw and washer. The motor shaft is to be manufactured from high grade steel and of reduced length to increase shaft rigidity, extend bearing life, and reduce the overall length of the pump and motor assembly. The motor shaft shall be protected with a replaceable stainless steel sleeve. The pump motor and impeller shall be removable from the back of volute case for service without disturbing the plumbing.

2.2 MOTOR

Pump motor shall be a squirrel cage induction horizontal solid shaft type. The pump impeller shall be direct mounted and keyed to the motor shaft with a stainless steel protective sleeve. The temperature rise of the motor shall be to NEMA Standard MG-1-12.42 for class B or Class F insulation. Radial and thrust bearings of ample capacity to accommodate the hydraulic thrust of the pump shall be incorporated into the motor. The motor shall be of proper size to drive the pump at any point on its operation curve without exceeding the motor service factor.

SECTION 3: PIPING MANIFOLD, VALVES, GAUGES AND OTHER MECHANICAL EQUIPMENT

3.1 FABRICATED PIPING

All fabricated piping shall conform to ASTM specifications A53 for Grade B welded or seamless schedule 40 pipe. All welded flanges shall be forged steel, slip-on or weld neck type. All welded fittings shall be seamless, ASTM Specification A234, with pressure rating not less than 150 PSI.

3.2 CHECK VALVE

Pump check valve shall be of the silent operating type that begin to close as forward velocity diminishes and be fully closed at zero velocity preventing flow reversal. Valve bodies shall be cast from ASTM-128C cast-iron or better and shall be free from blow holes, sand holes, and other impurities. The valve design shall incorporate a center guided, spring loaded poppet, guided at opposite ends and having a short linear stroke that generates a flow area equal to the pipe diameter. Internals shall be machined bronze disc, seat, and

stem guide. Valves shall be sized to permit full pump capacity to discharge through them without exceeding a pressure drop of 2.5 PSI. Valves 4" and smaller to be pressure rated for 250 PSI.

3.3 STATION DISCHARGE ISOLATION VALVE

Isolation valves shall be butterfly type with ten position lever for sizes 4" and smaller and gear operators for sizes above 4". All shall be rated at 200 psi WOG working pressure. Trim shall include stainless steel stem, bronze or nickel coated iron streamlined disc, and full faced resilient seat designed to eliminate need for flange gaskets.

3.4 DRAIN VALVES

Drains are to be provided from any possible low point in the system and are to consist of 1/4" brass petcocks.

3.5 PRESSURE GAUGES

A compound pressure gauge shall be located on the pump inlet piping and on the discharge manifold for easy reading of the suction vacuum/pressure and discharge pressure. Pressure gauges shall be 304 stainless steel case and bezel construction. Gauges shall be 3" diameter, liquid filled. Pressure sensing connection shall be 1/4" NPT lower gauge connection.

3.6 VARIABLE FREQUENCY DRIVE PRESSURE REGULATION

The variable frequency drive shall be IGBT based with selectable carrier frequency up to 15 KHZ. The VFD shall include terminals for incoming power, motor output power and control terminals.

The VFD shall generate a sine-coded, variable voltage/ frequency, three phase output for optimum speed control. The VFD shall incorporate power loss ride-through for a minimum of 2 seconds. VFD protective features shall include current limit, auto restart, short circuit protection, electronic motor overload protection and ground fault protection. The VFD shall have a push button programming display for easy access to operation parameters. The VFD shall be protected on the primary side by fuses of the appropriate amperage. Overload capacity: 120% rated output current for one minute. Voltage Fluctuation: +10%, -15%. Sine wave PWM with full range, automatic torque boost. Frequency Control Range: 0.1 to 400Hz. Frequency Accuracy: Digital: 0.01Hz, Analog: 1%. Motor overload protection, Instantaneous Over current of 180% of rated output current. Over voltage at 820VDC if 460V input. Under voltage: user adjustable. Momentary Power Loss: up to 2 second ride through. Electronic Ground Fault. LED capacitor charge indicator. Input Phase loss alarm. Ambient temperature range of 0 to 50 degrees C. Humidity of 95% non-condensing.

3.7 PRESSURE TRANSDUCER

A solid state pressure transducer shall provide a noise free, linear output proportional to discharge pressure. Transducer shall be solid-state, strain gauge type with integral voltage regulation and output accuracy not less than 0.25%. Transducer shall be constructed of stainless steel and rated for the pump station discharge pressure called out in the technical specifications.

SECTION 4: ELECTRICAL CONTROLS
All control panels must meet or exceed the Federal Communications Commission (FCC) Standard #15 for emitted and conducted noise

4.1 GENERAL PANEL UL FILE NO. E142155

The complete control panel assembly shall be built in accordance with the provisions of the National Electrical Code and shall bear the U.L. listing mark for NEMA 1 industrial control panels along with the pump station manufacturers' U.L. panel shop file number.

4.2 MOTOR COMBINATION STARTER-BREAKER

Each motor shall be protected by a MSP combination starter and breaker. Device will be UL 508 Type F. Motor starter protector and contactor are electrically and mechanically linked by means of a link module and adapter plate. All starters are suitable for use in group installation applications according to NEC-430-53(c).

4.3 MAIN STATION DISCONNECT AND FUSING

A three-pole, service rated main station disconnect shall be mounted in a separate NEMA 4 enclosure outside the pump station enclosure to completely isolate the pump station electrical system from incoming power. The service disconnect shall not be located inside the pump enclosure.

4.4 CONTROL HARDWARE

The pump sequence controller shall be an industrial grade PLC with diagnostic LEDs for monitoring of discrete inputs and outputs. Not less than two additional analog inputs and outputs shall be standard for monitoring and control purposes. The PLC shall contain RS232 and RS485 communication ports for monitoring and programming purposes. The PLC shall contain an EEPROM, battery backed RAM and non-volatile memory for storage of critical configuration data. The PLC will have a high speed counter, clock and calendar function with year, month, day, hour, minute, and day of week.

Automatic Pressure Regulation Based on Variable Flow

The pump station controls shall be capable of changing the regulated downstream pressure while in operation, based on discharge flow or discrete input as called out by the technical specifications. The pump station controls shall also be capable of up to six, user adjustable pressure regulation set points based on discharge flow or one additional set point based on a discrete input. In addition to adjustment of downstream pressure, the controls shall be capable of up six pressure regulation algorithms to insure accurate pressure regulation regardless of regulated pressure, discharge flow or connected pump combination.

4.5 Operator Interface

Operator interface shall be a full color STN active matrix LCD display unit mounted in the enclosure door. Operator interface shall be used for logical display of all pump station functions. The operator interface shall be NEMA 4 rated. The operator interface shall be touch sensitive with intuitive on-screen user instruction for ease of operator use. The use of buttons or keys or off-screen user instructions shall not be permitted. The operator interface shall be LCD color display type with no less than 640 x 480 pixel resolution, with viewing area measuring not less than 7.0" diagonal. User memory for storing critical pump operation data shall not be less than required for up to 1 year of data.

The operator interface shall allow the user to view and modify all pertinent operation parameters. The operator interface shall incorporate password protection for modification of critical pump station parameters. The operator interface capabilities shall include but are not limited to the following:

- a. Overview screen showing pump system configuration. Screen shall show if each individual pump is enable or disabled, the number of hours on each pump, station full flow and pressure design criteria
b. System screen with information on current regulation pressure, setpoint, regulation pressure, System status, restarts remaining, VFD reference speed, pressure regulation method (VFD or EDV modes) and adjust settings button. Adjust settings button will allow changing parameters etc after entering password.

- c. Settings menu to allow changes to pressure regulation settings, pipe saver mode, VFD manual mode, analog calibration, flow calibration, program or register settings.
d. Flow screen will display pressure in PSI, flow in GPM and total gallons pumped in thousands of gallons. Separate display for total gallons pumped since last reset.
e. Alarm status with time stamping, display of pump station conditions at shutdown and restart. Alarms will be displayed in red when activated and a separate listing will be displayed in green when the alarm is reset. Alarms will be logged to a compact flash disk allowing the service technician to upload data to a spreadsheet type program.
f. Full control of and capability of monitoring, adjusting and viewing any options present such as water level, inlet strainer, wye strainer, filtration, chemical injection, or liquid tank levels. Adjustment of automatic/manual pressure regulation set points.
g. Graphing capability for up to 1 full year detailing flow rate and pressure. Graphing function shall give option to graph and plot a point every minute. The graph function will be selectable by day, month and year as well as the time of desired graph. All data will be logged to a compact flash disk allowing the service technician to upload data to a spreadsheet type program.

4.6 SECONDARY CONTROL CIRCUIT FUSES

Single-pole secondary distribution fuses with appropriate ratings shall supply power to the pump starter coil circuit, the control system and to other circuits as specified.

4.7 PUMP THERMAL SWITCH

The water temperature entering the pump shall be sensed by a thermal switch. The thermal switch shall be located at the entrance to the pump and shall be screwed into a pipe fitting either in the pump case or a dedicated pipolet. Externally mounted snap disc type thermal switches will not be accepted. The thermal switch shall activate upon a temperature rise above 120 degrees Fahrenheit.

4.8 FLOW SENSOR

The pump station discharge manifold shall incorporate an insertion type, pulse frequency output flow sensor for continuous output to the pump station controls. The flow sensor output pulse shall be conditioned and fed directly to the PLC interrupt input for conversion and display in Gallons Per Minute and totalize. For accuracy and security considerations, conversion to an analog signal prior to PLC input shall not be accepted. Flow sensor accuracy shall be no less than 2% for flow velocities ranging from 1-30 feet per second.

4.9 NATIONAL ELECTRICAL CODE STANDARDS

Electrical controls shall conform to National Electrical Code Standards and be U.L. listed

4.10 LIGHTNING ARRESTOR

The main power supply to the pump station shall be equipped with a secondary lightning arrestor having a breakdown current rating of not less than 80,000 Amps at 14,000 Volts discharge. Power supplies 300 Volts and less shall use a 300 Volt arrestor with an 800 Volt spark-over Voltage. Power supplies up to 600 Volts shall use a 600 Volt rated arrestor with a 1,000 Volt spark-over Voltage.

4.11 CORROSION INHIBITING MODULES

Corrosion inhibiting modules shall be installed in the main electrical control enclosure in accordance with the manufacturer's recommendations.

4.12 LOW DISCHARGE PRESSURE SAFETY SHUTDOWN

Low discharge pressure is to be sensed by the pump starting set point. When the station discharge pressure decreases to this point and maintains a start signal for the time called out in the Technical Specifications, the pumps will be de-energized and remain so until the circuit is manually reset. The operator interface shall illuminate to indicate a low discharge pressure shutdown has occurred.

4.13 HIGH DISCHARGE PRESSURE SAFETY SHUTDOWN

High discharge pressure is to be sensed by the pump starting set point. When the station discharge pressure increases to this point and maintains a start signal for the time called out in the Technical Specifications, the pumps will be de-energized and remain so until the circuit is manually reset. The operator interface shall illuminate to indicate a high discharge pressure shutdown has occurred.

4.14 HIGH PUMP VOLUTE TEMPERATURE SHUTDOWN

If the pump volute case temperature rises above 120 degrees F. for the time called out in the Technical Specifications, the pump will be de-energized and remain so until the circuit is manually reset. The operator interface shall illuminate to indicate a High Temperature Cutout has occurred.

4.15 VFD FAULT ALARM

The operator interface shall illuminate to indicate a VFD shut off fault. Manual reset required.

SECTION 5: MOUNTING BASE & ENCLOSURE

5.1 STAINLESS STEEL MOUNTING BASE

Construction shall include a fabricated stainless steel base assembly to support all components during shipping and to serve as the installed mounting base. Pump station base shall be formed from a single sheet of 1/4" plate resulting in a seamless, one piece base with rounded edges and corners. The base shall be strategically reinforced beneath as required to provide additional support and strength. Standard base dimensions are 50" long, 34" wide, 3-1/2" high. The base shall be drilled and tapped allowing the pump and manifold to be secured to the base. The exterior of the base will be drilled to accept anchoring bolts.

5.2 MARINE GRADE ALUMINUM ENCLOSURE

Construction shall include a weather resistant, 14 gauge, all metal enclosure with welded lockable lid guides on top and bottom. The front side of the enclosure shall have oversized cooling vents. The enclosure is to be supplied with two internally mounted heavy duty latch that shall lock to keep the access door open. All components are to be accessible from top and front sides with the door completely open. Enclosure is to be suitable for mounting to the pump station base and shall include openings for suction and discharge piping.

5.3 EXHAUST FAN

For the purpose of cooling the pump motor, switchgear and control logic, an exhaust fan shall be located inside the pump enclosure, mounted to the enclosure. The exhaust fan shall be activated upon pump start and shall run until the pump stops. The fan shall be black die-cast aluminum construction with UL94V-0 rated

polycarbonate propeller and rated for not less than 240 CFM. Fan motor shall be permanent split capacitor type with stainless steel ball bearings, class B insulation and automatic thermal protection.

SECTION 6: PAINTING (Piping)

Painting of the entire pump station shall consist of a multi-step coating system which includes metal preparation, rust inhibitive baked epoxy prime coat, and a two part ultraviolet light insensitive baked polyurethane finish having total dry film thickness of not less than 5 mils. Prime coat and finish coat shall be baked at 165 degrees for not less than 30 minutes to achieve a high gloss, corrosion resistant finish. Sandstone is standard.

SECTION 7: ADDITIONAL EQUIPMENT

7.1 DROP PIPES

The inlet and discharge piping system will be attached to dual 90 degree drop pipes to provide below grade connection to a suction pipe or city water supply pipe or below grade connection to a discharge main line. Drop pipe sizes, connection fitting style and depth of bury will be shown on the project drawings.

7.2 SERVICE DISCONNECT

The incoming high voltage disconnect shall be supplied as a Dead Front style.

7.3 RESERVOIR LEVEL CONTROL

The irrigation reservoir shall be continuously monitored by an electronic pressure transducer which will send a 4-20ma signal to the PLC. The reservoir level will be read on the Touchscreen operator interface and displayed in inches. The user shall be able to control the remote signal activation level by making the desired adjustments on the screen. When low (set point) level has been maintained for the pre-set period of time, a 120 VAC signal shall be sent to a dry contact relay in the pump station panel to activate the start signal for a fill pump or valve. Upon a rise in the reservoir level the signal will stop and the relay will drop out to stop the filling operation.

7.4 AUTO-FLUSHING FILTER

The pump station discharge piping system will include an automatic flushing filter. The filter brand and style will be dependent on station's maximum gallons per minute design point. The filter model number and micron level of filtration will be called out in the Technical Specifications.

SECTION 8: TESTING

The pump station and all its component parts shall undergo a complete hydraulic and electrical test prior to shipment from the factory. Testing shall be dynamic and include operation over the entire flow range of the pump station under specified suction and net discharge pressure conditions. A plot containing actual flow, pressure, KW consumption and motor RPM shall be furnished as part of the owners manual.

SECTION 9: OWNERS MANUAL

Complete start up instructions shall be provided by the manufacturer in the form of an owners manual.

SECTION 10: WARRANTY

The manufacturer shall warrant the pump station to be free of defects for one year from date of start up or fifteen months after shipment, whichever occurs first. Failures caused by lightning strikes, power surges, vandalism, operator abuse, or acts of God are excluded from warranty coverage.

TECHNICAL SPECIFICATION

Table with 2 columns: Starting Equipment, Controls, VFD Controls. Values: U.L. Listed as an Industrial Control Device, U.L. Listed as an Industrial Control Assembly, U.L. Listed as an Industrial Control Assembly.

Table with 3 columns: Zone, Flow (GPM), Pressure (PSI). Values: 1, 200, 80.

Table with 2 columns: Operator Interface, Touch Screen. Value: X.

Table with 2 columns: Safety, Setting. Values: Incoming Phase Failure and Low Voltage and Phase Reversal: 10% +/-, Individual Power Phase Failure and Low Voltage: 10% +/-, Low Discharge Pressure Shut down: 25 PSI Below Setpoint, High Discharge Pressure Shut down: 15 PSI Above Setpoint, Individual High Pump Temp: 120 Degrees F, Low Inlet Pressure/Loss of Prime: 0 PSI at Intake.

Table with 3 columns: Station Intake / Discharge Information, Intake Z Pipe, Discharge Z Pipe. Values: 1, 4" FL, 4" FL.

Table with 5 columns: Manufacturer, Size, Quantity, Model, Micron. Values: Tekleen, 3", 1, MTF, 120.

Table with 2 columns: Enclosure Material, Base Material. Values: Aluminum, Stainless Steel.



ARCHITECTURE PLANNING

North Carolina
3333 Jaeckle Drive, Suite 120
Wilmington, NC 28403
910.341.7600
Maryland
312 West Main St, Suite 300
Salisbury, MD 21801
410.546.9100
Delaware
309 S Governors Ave
Dover, DE 19904
302.734.7950
Rittenhouse Station
250 South Main Street, Suite 109
Newark, DE 19711
302.369.3700
www.beckermorgan.com



611 Burroughs & Chapin Blvd. • Suite 202
Myrtle Beach, SC 29577 • 843.839.3545
www.thomasandhutton.com



PROJECT TITLE

HGTC - GRAND STRAND LANDSCAPING AND IRRIGATION

743 HEMLOCK AVENUE
MYRTLE BEACH, SC 29577

S.C. O&E PROJECT NUMBER:
H59-NO35-MJ

SHEET TITLE

IRRIGATION PUMP STATION SPECIFICATIONS

Table with 2 columns: Issue No., Description. Multiple empty rows.

04/19/2021 ISSUED FOR BID

PROJECT NO: J - 27742.0002

DATE: 04/19/2021

DRAWN BY: MDC PROJ MGR: WAW

IR113

COPYRIGHT © 2019